

Jan Kotek

LABORATORY TECHNIQUE

2022, preliminary translation



CHARLES UNIVERSITY, FACULTY OF SCIENCE

This textbook belongs to the subjects „Laboratory Technique (a)“ and „Laboratory Technique (b)“, which are held at Department of Inorganic Chemistry of Faculty of Science, Charles University, from school year 2018/19. It is an upgrade of textbooks used in the past (hardcopy textbook J. Kotek: Laboratorní technika, Karolinum, Praha 2007; or later electronic textbooks with versions lower than 4.1). Starting from school year 2018/19, the subject matter was innovated, which need to revise the text significantly. Although the recent version and the former ones are almost completely overlapping in theoretical part, the experimental instructions changed a lot. In several experimental procedures, some changes were made even comparing to version 4.0, which was used in the winter term of 2018/19 (when the experiments were tested), so starting from the summer term of 2018/19 it is necessary use the more recent versions (4.1 or higher). **None of the former versions is now fully usable for successful passing of Laboratory Technique subjects.**

I would like to express my cordially thanks to former and present colleagues from Department of Inorganic Chemistry, which were involved in work on the textbooks, made some impulses, commented on the previous versions and were sources of valuable advices and commentaries.

I thank very much to prof. Jan Budka for several illustrations which accompany the textbook.

The textbook is published in electronic form and is accessible through Student's Information System of Faculty of Science, Charles University (<https://is.cuni.cz/studium>) or through platform Moodle (<https://dl2.cuni.cz>).

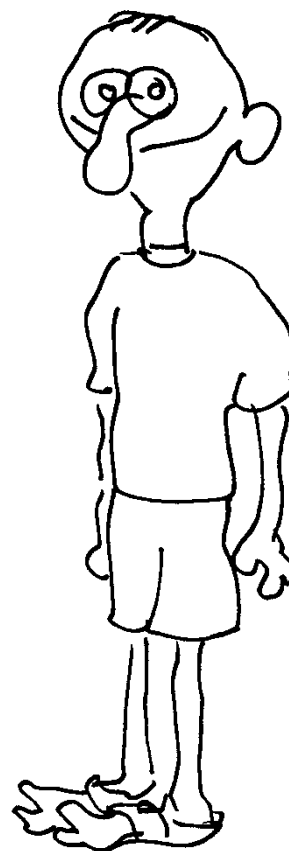

Author

Table of contents

| | |
|---|-----------|
| 1. Introduction | 6 |
| 1.1 Experimental results | 6 |
| 1.2 Writing of protocols and typography | 7 |
| 2. Safety rules for work in chemical laboratory | 13 |
| 2.1 Safety rules | 13 |
| 2.2 First aid..... | 14 |
| 3. Laboratory equipment | 15 |
| 3.1 Laboratory glass | 15 |
| 3.1.1 Ground glass joints..... | 16 |
| 3.1.2 Test tubes..... | 16 |
| 3.1.3 Beakers | 16 |
| 3.1.4 Flasks..... | 17 |
| 3.1.5 Funnels and powder funnels..... | 18 |
| 3.1.6 Separating and addition funnels | 19 |
| 3.1.7 Condensers | 19 |
| 3.1.8 Distillation and receiving adapters | 20 |
| 3.1.9 Tubes with socket and cone (reduction tubes) | 20 |
| 3.1.10 Safety flasks (Woulff bottles) | 20 |
| 3.1.11 Bubbles counters, gas washing bottles and cold fingers | 21 |
| 3.1.12 Frits and filtration adapters | 22 |
| 3.1.13 Watch glasses, Petri dishes..... | 22 |
| 3.1.14 Desiccators | 22 |
| 3.1.15 Thermometers..... | 23 |
| 3.1.16 Volumetric cylinders | 23 |
| 3.1.17 Pipettes, Pasteur's pipettes | 23 |
| 3.1.18 Burettes..... | 24 |
| 3.1.19 Stoppers..... | 24 |
| 3.1.20 Drying tubes | 24 |
| 3.1.21 Boats for weighting and weighting bottles..... | 25 |
| 3.2 Laboratory porcelain | 25 |
| 3.2.1 Büchner and Hirsch funnels | 25 |
| 3.2.2 Evaporation bowls/dishes..... | 25 |
| 3.2.3 Mortars and pestles..... | 25 |
| 3.2.4 Crucibles..... | 26 |
| 3.3 Laboratory metal equipment | 26 |
| 3.3.1 Stands | 26 |
| 3.3.2 Cross clamps, holders and rings | 27 |
| 3.3.3 Burners | 27 |
| 3.3.4 Boiling tripods, ceramic nets and triangles | 28 |
| 3.3.5 Crucible tongs, pincers and spatulas | 28 |
| 3.4 Laboratory equipment made of plastic, cork and rubber | 28 |
| 3.5 Laboratory instruments | 30 |
| 3.5.1 Stirrers, (magnetic) heating plates and heating nests | 30 |
| 3.5.2 Balances | 30 |
| 3.5.3 Sources of electric current..... | 30 |
| 3.5.4 Sources of vacuum | 30 |
| 3.5.5 pH-meter..... | 31 |
| 3.5.6 Vacuum rotary evaporator..... | 31 |

| | |
|--|-----------|
| 3.5.7 Melting point apparatus | 32 |
| 3.5.8 Refractometer | 32 |
| 3.5.9 UV-Vis spectrophotometer | 33 |
| 3.5.10 Laboratory furnace | 34 |
| 3.6 Chemicals, drying agents and solvents | 34 |
| 4. Basic laboratory procedures | 36 |
| 4.1 Assembly of apparatus | 36 |
| 4.2 Weighting | 36 |
| 4.3 Measurement of volume | 37 |
| 4.4 Measurement of temperature..... | 39 |
| 4.5 Measurement of pressure | 39 |
| 4.6 Determination of pH..... | 40 |
| 4.7 Heating | 42 |
| 4.7.1 Heating with gas burner and annealing | 42 |
| 4.7.2 Heating on steam bath | 43 |
| 4.7.3 Heating in bath | 44 |
| 4.7.4 Heating in heating nest..... | 45 |
| 4.8 Cooling | 45 |
| 4.9 Evaporation on vacuum rotary evaporator | 46 |
| 4.10 Crystallization | 46 |
| 4.10.1 Crystallization by change of solvent (precipitation) | 46 |
| 4.10.2 Crystallization by evaporation of solvent (reduction of volume) | 46 |
| 4.10.3 Crystallization by change of temperature..... | 47 |
| 4.11 Trituration..... | 47 |
| 4.12 Filtration and vacuum-filtration | 47 |
| 4.12.1 Filtration | 47 |
| 4.12.2 Vacuum-filtration on Büchner or Hirsch funnel and on frit..... | 49 |
| 4.13 Separation of non-miscible liquids and extraction..... | 50 |
| 4.14 Distillation..... | 51 |
| 4.14.1 Simple distillation at normal or reduced pressure | 52 |
| 4.14.2 Rectification | 54 |
| 4.14.3 Steam distillation..... | 56 |
| 4.15 Sublimation | 56 |
| 4.16 Chromatography..... | 58 |
| 4.16.1 Column chromatography..... | 58 |
| 4.16.2 Thin-layer chromatography..... | 58 |
| 4.16.3 Chromatography on ion-exchanger | 60 |
| 4.17 Determination of density | 61 |
| 4.18 Determination of melting point | 62 |
| 4.19 Determination of refractive index | 63 |
| 4.20 Work with gas cylinders (bombs) | 64 |
| 4.21 Work with melted glass..... | 65 |
| 4.22 Microsynthesis | 66 |
| 4.23 Titration..... | 67 |
| 4.23.1 Preparation of solution of given concentration | 68 |
| 4.23.2 Determination of exact concentration of stock solution..... | 69 |
| 4.24 Electrolytic processes | 69 |
| 4.24.1 Basic principles of electrolysis..... | 69 |
| 4.24.2 Galvanic electroplating | 70 |
| 4.24.3 Electrogravimetry..... | 71 |

| | |
|--|------------|
| 4.25 Absorbance measurement | 71 |
| 4.25.1 Absorption spectroscopy | 71 |
| 4.25.2 Lambert-Beer law | 72 |
| 5. Experimental instructions | 74 |
| 5.1 Experiment 1 – Crystallization..... | 74 |
| 5.2 Experiment 2 – Isolation of glycine and identification of unknown amino acid | 76 |
| 5.3 Experiment 3 – Identification and concentration determination of unknown organic acid | 80 |
| 5.4 Experiment 4 – Determination of melting point | 87 |
| 5.5 Experiment 5 – Spectrophotometric quantitative analysis | 89 |
| 5.6 Experiment 6 – Electrolytic preparation and electrogravimetry | 92 |
| 5.7 Experiment 7 – Determination of distribution coefficient of iodine | 96 |
| 5.8a Experiment 8a – Rectification | 98 |
| 5.8b Experiment 8b – Work with gases | 100 |
| 5.9 Experiment 9 – Vacuum distillation..... | 103 |
| 5.10 Experiment 10 – Determination of solubility of inorganic salt, and determination of content of water of crystallization in the solid sample | 106 |
| 6. Example of protocol | 110 |
| 7. Time schedule for performing experiments..... | 112 |
| 7.1 Time schedule for “Laboratory technique (a)” | 112 |
| 7.2 Time schedule for “Laboratory technique (b)” | 112 |

1. Introduction

During the laboratory course, you will work in pairs. The pairs will be formed in the beginning of the term and will be numbered. Individual experiments are scheduled according to the number of the pair, so note your number. The practicum takes place once a week in block of four hours. Each pair will pass during the term *all experiments* corresponding to the subject [*i.e.* experiments 1–10 in subject “Laboratory technique (a)” or experiments 1–5 in subject “Laboratory technique (b)”]. Time schedule of works on individual tasks is given in **Chapter 7**. It is also in Student’s Information System of Charles University (<https://is.cuni.cz/studium>), on Moodle platform (<https://dl2.cuni.cz>) and on notice board in laboratory. According your planned experiment, you will pick up a wardrobe key on the notice board. Put your clothes, boots and bags into the wardrobe, and come to the laboratory equipped with a lab-coat, lab-goggles, calculator, pen/pencil, laboratory diary, this textbook and – last, but not least – knowledge on the planned experimental work. It is useful to have also a piece of matter (cotton), marker, source of fire (matches, lighter) and a USB drive (data transfer during Experiment 5) in pockets of the lab-coat.

During the first week of the term, there is a lecture on safety work and only some administration works are done. The experiments start from the second week of the term. You have to pass an entrance test before the experimental work (the test is performed just before the experimental lecture in the second week). The test covers safety of work, basics of health protection during work in a laboratory, basic knowledge of laboratory glass and equipment, *i.e.* content of **Chapters 2** and **3** of this textbook. Basic chemical calculations are examined, too, together with balancing of chemical equations.

Check equipment of your working place according to the inventory list before a start of the experimental work. Report any missing equipment to a lab-assistant.

After your experimental work is finished, report your results to supervisors of the course. They must verify your results, and only after the verification is done, clean the working place and let the lab-assistant to check the place. Leave the laboratory only after the procedure. *Do not forget to give back the wardrobe key.*

The necessary condition for successful passing the courses Laboratory technique (a) or Laboratory technique (b) (and obtaining the appropriate credits) is *successful passing all the experiments* (with results accepted by the supervising teachers), *accepted all experimental protocols* and *successfully passed final test*. If – for any reason (disease etc.) – you will not pass some of the experiments in your parallel (according to your schedule), you have to pass in the alternative parallel. Find the suitable parallel in schedule shown in SIS and ask (in advance) the teacher who supervises it, whether there is a free space for your experimental work.

You have to be prepared for the experiment, which you are going to perform. If your knowledge will not be sufficient for the experimental work, the supervising teacher can exclude you from the laboratory. Repeated unconcern and missing home self-preparation for the experiment can lead to your exclusion from whole course.

1.1 Experimental results

Some results are required in end of individual experiments. It is e.g. prepared product (with calculated yield), and/or measured quantity of the studied sample (for example melting temperature, boiling temperature, refractive index, concentration, *etc.*), alternatively identification of the unknown isolated/studied compound. After you will reach the required result, report it to the supervising teacher (or show your product for a visual check) and the teacher will declare whether your result is acceptable. Only reported correct result (noted in your evidence card) can be taken as successful passing the given experiment.

1.2 Writing of protocols and typography

Mandatory part of the work is a writing of a protocol. Each student will *write the protocol alone by himself*. Presence of identical parts in protocols of two students (even from different groups) or with protocols accessible on Internet (www.primat.cz etc.) is unacceptable. Repeated copying of the protocols from classmates could be a reason for exclusion from the course.

Turn in the protocol about last performed experiment immediately at beginning of the next lecture, otherwise work on the next experiment will not be allowed. Only exception is if you will pass two (or more) experiments within one week (e.g. due to performing a missing lecture). Correct the protocols given back by teachers and turn them in at beginning of the next lecture.

Use suitable word processor for writing of the protocols (tips mentioned below are for the most frequent program MS Word). Create charts using suitable spreadsheet (tips mentioned below are for the most frequent processor MS Excel). *Turn in the printed protocols; use stapler to join individual sheets.*

The protocol is not instruction, but it is a report about your experiment. *Do not copy instructions from the textbook. Write the protocol in past simple passive* (e.g. “**Weighted amount of KCl (1.05 g) was added to...**”). Do not use formulations from the instructions (e.g. “~~Weight 1.05 g of KCl.~~” or “~~We will work with...~~”). A use of past simple or present perfect is also not preferred in scientific reports, *i.e.* do not write “~~I have weighted 1.05 g KCl~~”. It should be possible to repeat your experiment, including mistakes which were done. Therefore, it is necessary to describe all the procedures in detail, eventually including your observation, if something non-expected or potentially dangerous happened (for example, “the immediately after mixing the reactants the mixture become warm and changed colour from green to red”, “the mixture blew up”, etc.).

During your experimental work note carefully all relevant information into a (paper) notebook for later use in the protocol.

When writing the protocol, it is useful to switch on the grammar and spelling check (e.g. in MS Word, all unusual words are underlined by red and unusual syntax by green wavy lines) which brings your attention to possible errors. However, use of automatic corrections is not recommended, as in scientific texts, some specific terms have close spelling to usual words, and the text processor will correct them obstinately. In such a case, you will never write “reflux” (it will be permanently changed “reflex”), some formulas with two capital letters will be changed, e.g. HCl to Hcl, after a dot at the end of some short (e.g. “ca.”) the program will capitalize the first letter of the next word as formally a new sentence should begin, etc. In extreme, spelling of some personal names will be changed to more usual related names – e.g. prof. Kubicek becomes due to automatic correction to be prof. Kubrick.

The protocol must contain following:

Datum, name of student(s), number of working group.

Number and title of the Experiment.

Experimental aims.

Short theoretical introduction describing the principle of the experiment. Describe shortly also non-trivial methods used. *Do not copy paragraphs from the textbook. Do not “unthinkingly” copy sentences from the textbook or other sources. Use your own brain* – it helps to organize information and to understand basic principles of processes.

Description of the experiment. This part must be self-supporting and must be sufficient for repetition of your experiment by anyone else. In the future (*e.g.* when writing Bachelor/Diploma Thesis or publications), you will present your experimental work only by this chapter. **Therefore, all relevant information (weights, times, reaction conditions, results of calculations) must be here.** In the case of synthetic reports, do not report only weights, but also amount of substance of individual compounds – a reader will easily see molar ratios in the reaction mixture. **Mention a yield at the end of the synthetic procedure.** In the future, nobody will try to find such information in other chapters (calculations *etc.*). Do not describe trivial and implicit procedures. Instead of sentence “The apparatus for vacuum filtration was assembled and the product was isolated on frit. After filtration, it was transferred to watch-glass and weighted. The weight was 1.38 g, which correspond to 66%.”, use simply “Vacuum-filtration on frit afforded 1.38 g of product (66%).” **If the starting material was some unknown sample, do not forget to write a label (number) of the sample.** Use past simple passive for description of the procedure.

Calculations and results. In the protocol, there must be all primary data acquired during experimental work. Results of repeated experiments should be tabularized. **Tables must be unambiguously labelled with appropriate captions and should be referred in the text.** Present the procedure of your calculations in order to find potential mistake. Use intelligible titles of your calculations to be clear what you calculated. **Use appropriate units.** Do not forget, that the most important chemical quantity is *amount of substance, n*. Its unit correspond to number of particles, “balls” (atoms, molecules *etc.*) which enter the reaction or “roll out” of the reaction. Thus, influence of this quantity should be included in all stoichiometric calculations.

When rounding your results, take care on reasonable accuracy of your work. Typical mistake is so called *syndrome of calculator*, *i.e.* thoughtless writing down of the number shown on the calculator’s display. The result should be rounded to such number of digits according to quantity with the lowest accuracy. Attention – do not mix up number of digits with number of decimal places. The number 0.1234 has four digits and four decimal places, whereas number 123,4 have also four digits, but only one decimal place. Example:

You have prepared 2.63 g of the product by reaction of 1.75 g of starting compound. Theoretical yield should be 3.12 g. Yield of your reaction was:

$$\text{yield} = \frac{2.63 \text{ g}}{3.12 \text{ g}} = 0.84294871794.$$

As all weights are given with accuracy to three digits (and are in this case loaded by error ± 0.005 g; the error is given by rounding of the weights to two decimal places). It is unreasonable to round the result to more than to three digits, *i.e.*:

$$\text{yield} = 0.843 = 84.3\%.$$

Note: the yields of chemical reactions are usually given rounded to integer percent (*i.e.* with accuracy of two digits). In given case it should be 84%.

Think about results of your calculations. Use common sense – think about reality of the result, and confirm units. Check order of your calculations carefully (*e.g.* if the result is in kilograms, in grams or in milligrams, *etc.*).

If there is a zero in the last reasonable digit of your calculation, write it, it is important. If you write “weight of 1 g”, it means that you weighted 1 g with possible inaccuracy ± 0.5 g, so in practice the weight could be in range 0.5–1.5 g, which is very big. In the contrary, a value of 1.00 g means accuracy ± 0.005 g so real weight is in the range 0.995–1.005 g.

Sometimes it is necessary to determine a given quantity as accurate as possible. Therefore, measurement can be repeated several times, and the results are finally averaged. In such case the accuracy of the average can be compared to individual values higher by one digit. But, use

the common sense also in this case and consider also dispersion of the individual values. So, from the dataset 0.0123, 0.0123, 0.0122 and 0.0123, the average is 0.01228 which seems to be reasonable. From dataset 0.16, 0.17, 0.21 and 0.19, the average 0.183 is calculated, but its last digit obviously does not abound with credibility. Criteria for determination of variance and standard deviation are rigorously defined by mathematical statistics. However, its calculation is out of the scope of this course and you will meet them in future study.

From typographical point of view, a special attention on correct writing of symbols of quantities, their values and their symbols should be paid. Symbols of quantities should be written in italics, for example pressure p , mass m , molar mass M , volume V *etc.* In contrary, subscripts/indexes are usually written by normal font, *e.g.* relative molar mass M_r , pressure of water vapour p_{aq} , mass of the first sample m_1 , consumption acquired during third titration V_3 *etc.* The exception is only if the subscript represents other quantity (if one quantity is dependent on the other). In such case, the symbol in the index is written in italics, too. For example, extinction coefficient and refractive index are dependent on wavelength which is represented as ε_λ and n_λ . Alternatively, the dependence of one quantity on other can be represented with use of parentheses, *i.e.* $\varepsilon(\lambda)$ and $n(\lambda)$. The reason for use of parentheses is less complicated notation in the case if there was some index (sub/superscript) also in “independent” quantity. For example, concentration of copper(II) chloride can be written as $c(\text{CuCl}_2)$ instead of more complicated form c_{CuCl_2} which (besides others) leads to change of line spacing and to unsightly appearance, as can be seen also in this text. The variant c_{CuCl_2} is ugly and do not need other commentary. However, if the value of independent quantity is well defined, for example if extinction coefficient at wavelength 480 nm is given, the value is used in the subscript in regular font, *i.e.* ε_{480} .

The exception is quantity pH – **it is written in regular (normal) font, not in italics.**

Similarly top symbols of quantities, also symbols of constants are usually written in italics, *e.g.* Avogadro number “ N_A ”, Boltzmann constant “ k_B ”, elemental charge “ e ”, gas constant “ R ” *etc.* However, different publishers can apply different typographic rules and use regular font for constants. Nevertheless, used form should be consistent through whole document.

Write space between value of the quantity and its unit. Exception is if the unit has meaning of adjective, for example 10ml flask is ten-millilitre-flask, 5M solution means five-molar-solution *etc.* Contrary, when the unit has meaning of noun, the space should be given, *e.g.* volume of ten millilitres is written as 10 ml, concentration of five mol per litre is 5 M. Exception is use of percent, where no space is often written even in meaning of noun, yield of fifty-six percent = fifty-six-percent-yield = 56%.

Especial attention should be paid on writing of “minus”. When pushing the key “minus” on the keyboard, MS Word will show hyphen (“-”) which is wrong (from typographic point of view) and is used as punctuation mark to join words (mother-in-law *etc.*) or to separate syllables. Correct “minus” is a sign which is longer. Its length is the same as that of “plus” mark and “equal to” sign and is placed at the same height from baseline as horizontal bar in “plus”. Mentioned mathematical symbols look like “- + =”. “Minus” can be typeset from “symbol” keyboard in section of “mathematical operators”, or using hexadecimal Unicode keyboard code – writing number 2212 and simultaneous pushing “Alt” and “x” keys. In some MS Word versions the order “Alt”+“2212” (*i.e.* writing number 2212 when key “Alt” is pushed) work, also. In some font sets the “minus” sign is not trivially accessible. In such cases, dash “-” can be used instead. The dash can be typeset using ASCII code with order “Alt”+“0150”, or automatic corrections can be employed when sequence “some letter – space – hyphen – space – some letter – space or Enter” is written. So, after typesetting *e.g.* “a - a” and writing further space or Enter after the last character the automatic correction will change it to “a – a”. Other problem rises from multiplication sign. It is recommended to use a “middle-dot” from “Symbol” keyboard, or to use hexadecimal Unicode code 2219, “.”

(writing 2219 and simultaneous pushing “Alt”+“x”). The same sign can be used also as adduct sign, *e.g.* in hydrates as $\text{CuSO}_4 \cdot 5\text{H}_2\text{O}$. Smaller “middle-dot” “.” can be also used (“Alt”+“0183”), but do not use asterisk “*” or small eks, “x”. Use of cross, “×”, should be limited to vector (not scalar) multiplication. Potential problems could rise also from use of division sign. When pushing division sign (slash) on the keyboard, the character “/” is shown, which has a slightly different slope than the right one “/” (“Alt”+“2215”). However, this change is in general acceptable.

Other note regards to decimal separator. In Czech, the decimal comma should be used (*e.g.* 123,4), whereas in English, the decimal point is used (123.4).

The last note regards to symbol of degree. It should be a circle touching the upper border of the row. The circle has the same width along whole circumference. The right sign is in symbol keyboard and look like “°”, not “º”, “◦” or even letter “o” in superscript, “^o”. Angular degree is the only unit, which is not separated from a numerical value by space. Contrary, degree of Celsius (centigrade) is separated by space. So, the right angle is 90°, whereas the water boils at 100 °C.

Graphical presentation of results. In several Experiments, a graphical output of your work is required (*e.g.* spectrum, calibration lines in analytical tasks, potentiometric curves, time dependence of measured quantities, *etc.*). **The graphs (charts) must have caption and appropriate formal attributes (name of the graph, axes description, units of quantities on axes, *etc.*).** Graphs should be referred in text of the protocol.

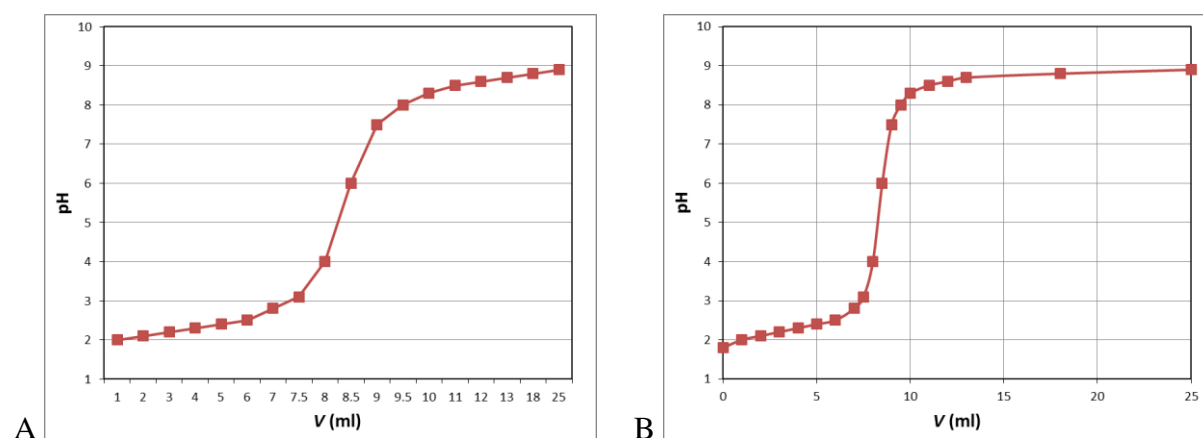

Fig. 1. Titration curve constructed as A) line chart (wrong), and B) XY (scatter) chart (correct). Notice labels/scale on the x axis.

The main problem usually rises from incorrect choice of the graph type. If you are using MS Excel, it is necessary to choose chart type “Point” (or “x-y”, a name differs among different Excel version), but not “Line” (which is, unfortunately, usually the default one). The “Line” type of chart uses evenly scaled x-axis and just shows data in order used in the table. Points on the x-axis are shown just by its ordinal number and the value of the independent quantity is only name/label of given point. Data-points cannot be (in the most MS Excel versions) interpolated by theoretical function (*e.g.* regression). If some versions allow calculate any regression from such data, the result is completely meaningless, as in such a case the program used ordinal numbers of given data-points (*i.e.* 1, 2, 3...) as values on the x-axis, which in the most cases differs from real values of the independent quantity. Only “Point” chart uses values of independent quantity (x) as numbers and final chart is shown in Cartesian coordinates. The difference between mentioned chart types is shown in **Fig. 1**.

The charts should be in reasonable format (size, height/width ratio) and the range of values on

axes should be chosen appropriately that the curve covers most of the chart area. Chosen step on the axes should be reasonable to assure good readability of the labels, see [Fig. 2](#).

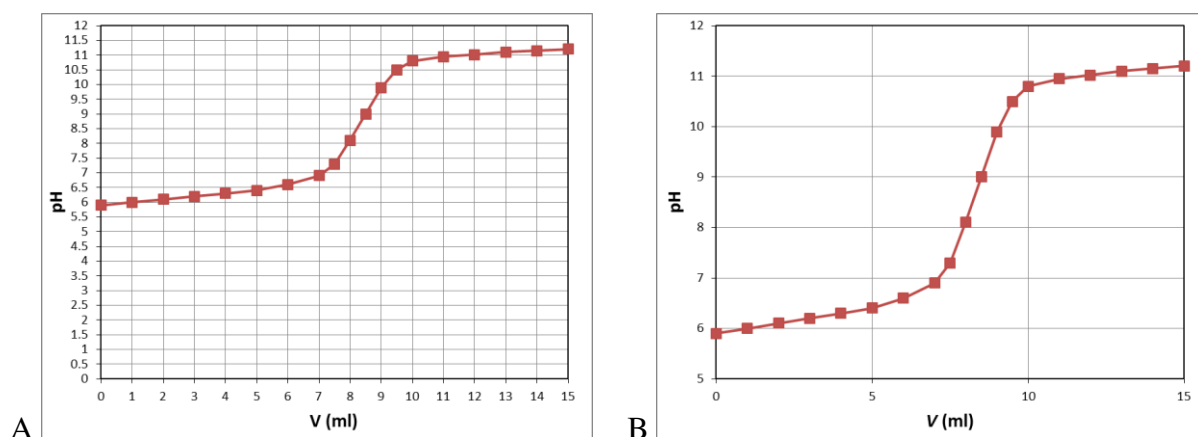

Fig. 2. A) Titration curve constructed in a wrong way – improper use of chart area, too small step between labels on x and y axes, too bushy grid, not used italics for volume V . B) The same data presented in more appropriate way.

According to a number of the fingers on standard human’s limbs it is suitable to choose numerical steps as multiple of 5 or 10; the chart, which uses axis steps in interval of *e.g.* 7 (*i.e.* 7, 14, 21, 28...) is confusing for readers and appears at minimum unusual, see [Fig. 3](#). If you want to underline a trend of the measured data, you can join the data-points with line segments (more correct, but toothed) or use smoothed line (good-looking). Attention, automatic smoothing algorithm in some spreadsheets sometimes leads to nonsense (and physically unjustified) waves on the smoothed line – in such a case, it is better to use toothed line consisting from segments. The line should be labelled as “guide for eye”, see [Fig. 3](#).

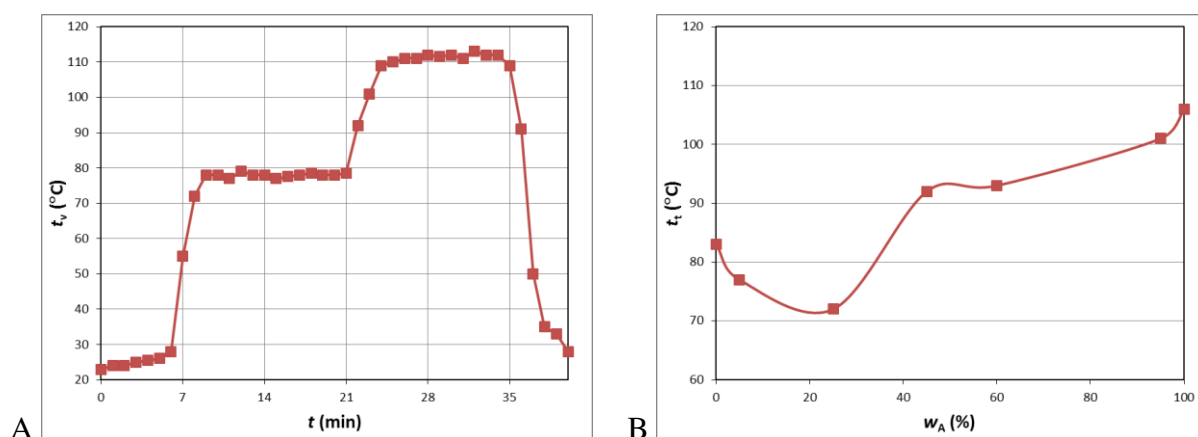

Fig. 3. A) Improper displaying of dependence of boiling point on time – non-standard step on the x axis. B) Improper use of smoothed line for interlaying of experimental data (notice a wave on the curve).

In *Summary* chapter, final results of the Experiment should be presented. Explanation of deviation of the results from expected/tabulated values should be discussed. Do not write personal evaluation of type: “~~We really enjoyed the Experiment.~~” or “~~During the task we learned...~~”.

Example of the protocol is given in [Chapter 6](#) of the textbook. Specific requirements on protocols from individual Tasks are outlined in instructions of Experiments.

In following paragraphs, there are some errors/mistakes which are frequently appearing in the protocols (ALL used mistakes were really present in turned protocols, fortunately, not together). Try to find them and correct.

1.24g of Na₂SO₄ and 3.22g of CuSO₄*5H₂O were added into a 50 ml Erlenmeyer flask. Stirring bar added and 20 ml of water. The mixture was dissolved by heating to 85 °C on heating stirring plate. The solution was filtered into 100ml beaker and left to crystallize overnight. Crystals of Na₂Cu(SO₄)₂*6H₂O was sucked off on the frit, washed with 10 ml of EtOH and dried by air flow. Yield 2,28 g (44 %).

From samples of compounds A and B, the mixtures containing 0, 5, 25, 45, 60, 95 and 100% of the compound A (content of the compound B was complementary to 100%). Mixtures were homogenized by grinding in the mortar and set of capillaries was filled with the mixtures (2 capillaries were used for each sample) to height of 3mm. The capillaries were put into automatic melting point apparatus and melting temperature was determined. The results are shown in Chart no. 1.

Chart no. 1 – melting temperature of mixtures of compounds A and B.

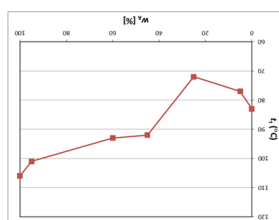
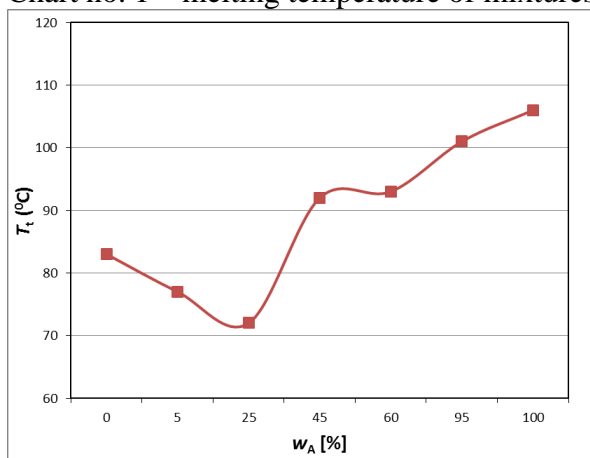

Chart 1 – melting temperature of mixtures of compounds A and B.

From samples of compounds A and B, the mixtures containing 0, 5, 25, 45, 60, 95 and 100% of the compound A (content of the compound B was complementary to 100%). Mixtures were homogenized by grinding in the mortar and set of capillaries was filled with the mixtures (2 capillaries were used for each sample) to height of 3 mm. The capillaries were put into automatic melting point apparatus and melting temperatures were determined. The results are shown in Chart 1.

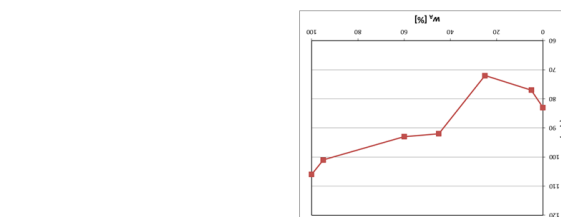

Chart no-1 – melting temperature of mixtures of compounds A and B.

The results are shown in Chart no-1. From samples of compounds A and B, the mixtures containing 0, 5, 25, 45, 60, 95 and 100% of the compound A (content of the compound B was complementary to 100%). Mixtures were homogenized by grinding in the mortar and set of capillaries was filled with the mixtures (2 capillaries were used for each sample) to height of 3 mm. The capillaries were put into automatic melting point apparatus and melting temperatures were determined. The results are shown in Chart 1.

2. Safety rules for work in chemical laboratory

Chemical laboratory is a working place, where you can meet a number of potential safety and health risks. Non respecting rules of the safety work in the laboratory can lead to injury of the offender as well as of other persons, and can cause a large damage. Therefore, it is necessary that all persons working in the laboratory observe the rules and avoid any dangerous situation. If such situation occurs, protect health of other persons and damage on the equipment accordingly to your abilities. Any student attending the course has to know the rules described below and observe them.

2.1 Safety rules

Besides well-known rules, that *it is not allowed to eat, drink and smoke in the chemical laboratory*, there are come more rules, which are not so obvious. They are discussed below.

Pregnant women are not allowed to work in the chemical laboratory.

Do not use the mobile phone in the laboratory. Switch it off or at least switch it into the silent mode. Sudden noise can lead to shock and impetuous reaction.

Wear a lab-coat when working in the laboratory. The lab-coat should be made of cotton and must have buttons in front (the coat which is worn over a head is not acceptable – if it is stained with some chemicals, it is not possible to take off the coat easily). It is useful to have a piece of cotton matter (for *e.g.* wiping small amounts of some spilled solutions) in the pocket of your lab-coat. Inside the laboratory, *you have to wear protective glasses*. It makes no difference if you are performing experiment or “just” writing/calculating – a danger for your eyes can come from your colleague working in neighbourhood. It is possible to use “normal” glasses if they have reasonably big area. Use of contact lens in laboratory is forbidden. Long hair is also risky – tie it into ponytail. Wear shoes with solid heel – do not use mules, which can make problems if fast moving is necessary. *Wear protective gloves when working with corrosive substances (acids, alkaline solutions).* *Use protective sheet when working with vacuum.* Be careful when working with chemicals (not only with corrosives) and avoid a contact of them with skin. If occurs, wash the stained place with water and – if necessary – use suitable medication.

Performing other Experiments than those according to official schedule is not allowed. If you need to complete some missing Experiment in other parallel, you need in advance an agreement of the teacher. Before start of the work (during homework preparation), it is necessary to grasp course of the experiment and understand reasons for all procedures. If you do not understand sense of some procedure even after careful repeated reading of the instructions, **ask a teacher for advice. It is not a shame.** Written instructions can be changed only by a teacher, follow carefully the instructions and/or potential teachers’ advices/changes. Complicated apparatuses should be built with the highest attention. *Apparatus with running experiment must be watched all time.*

Pay attention on tidiness and cleanness. There cannot be unused material on the table or in the fume hood. Wash dirty lab-ware from chemicals as soon as possible after use. Spilled water/oil/solutions or spread chemicals on table or floor must be cleared away immediately.

Any unknown chemical is potentially dangerous, treat it accordingly.

Vapours of metallic mercury are very toxic. If some mercury is spread (*e.g.* if thermometer or manometer are broken), it is necessary to avoid leaking of mercury into interstices or under furniture. Using wet filtration paper, move mercury droplets together into big drops and pick up them into a small bottle. Remaining mercury must be treated chemically. Sprinkle it with zinc or sulphur dust (it forms non-volatile amalgam or insoluble HgS, respectively) and inform the teacher about the accident.

When working with volatile flammable compounds, work far from open fire. Ideally, work in a fume hood (check that an exhaust is switched on). Also with poisonous or irritant compounds, work in a fume hood.

When some flammable liquids are spilt, switch off all burners immediately. When bigger incident came, switch off also electric power to whole lab (using the main switcher right from the main door) and start intensive ventilation.

Do not suck liquids to pipettes using your mouth. Use pipetting piston or balloon.

It is worthy to notice, that effect of chemicals is individual. The same exposition can bring no problems to most of people, whereas for some persons can cause severe allergic reactions, dermatitis, etc.

After teacher has checked your results/products, put chemicals to dedicated vessels. Use appropriate bottles for liquid waste (waste solvents, remains after distillation, etc.). Waste solvents should be sorted to chlorinated and non-chlorinated – it is necessary due to different waste treatment during waste disposal.

Remains of the chemicals (during washing of lab ware etc.) flush to the sink with lot of water. Solid remains can be thrown into waste bins under the sinks and beside the working tables. *Broken glassware should be thrown into a special waste bin placed under the sinks and labelled “SKLO”.*

Escape ways must stay free all the time. Therefore, leave bags and big briefcases locked in wardrobes on the corridor.

Be careful when working with electric devices. Do not touch heating plates of stirrers and heating nests. Besides burning, it can lead also to injury by electric current. *Touch the switchers only by dry hands.*

If some fire occurs inform all others by loud shout “fire”. Take action according to teachers’ instructions. Try to stop fire enlargement within range of your ability (remove flammable material away from the fire) and help with fire liquidation. There is anti-fire fabric in the laboratory (non-flammable textile which can be thrown over a flame and prevents access of air) and fire extinguisher. The decision on use of these materials lies on the teacher. *When conflagration starts, move out from the laboratory.*

2.2 First aid

The first air when eyes or skin are struck with any chemicals is immediate washing of the place with stream of water. Do not perform neutralization reactions if you were exposed to acid/base, but always wash with water first. When an eye was struck, it is necessary to wash it as soon as possible (fraction of a second play a role in this case), but when skin is exposed, secondary injury can unnecessarily occur during uncontrolled dash of a student to a sink. The skin survives several second without any damage even if exposed to e.g. concentrated sulphuric acid, therefore, move to the sink smoothly without chaotic collisions with colleagues.

If some small *burning* occurs (e.g. when touching a hot item), it is necessary to *cool the affected place under stream of cold water.* Do not wash bigger injuries, but just cover them by sterile matter. *In such case it is necessary to seek medical attention.*

If occasional swallowing of some chemical occurs, the cases are treated individually according to character of the chemical. *Do not try to neutralize a caustic chemical in the stomach.*

If gas poisoning occurs (chlorine, ammonia, hydrogen sulphide, carbon monoxide), it is necessary to move poisoned person to fresh air and keep him at rest. In the case of hard poisoning it is necessary to seek medical attention.

All injuries (including not “chemical”, e.g. cutting with broken glass) must be recorded. Report it to the teacher. Next action will be decided by the teacher.

3. Laboratory equipment

Chemical laboratory is a room dedicated to perform the chemical experiments. Most of laboratory work is done on laboratory tables. The tables are connected to water and water-waste system and to electricity (230 V), and sometimes are also equipped with burning gas and three-phase electricity (3×400 V). There are usually small sinks under each water inlet. On side of the table row, there are big ceramic sinks with cold/hot water.

There are two waste bins placed in boxes under sinks. One of them is dedicated for common waste (used filtration papers, boiling stones, etc.), the second is labelled by “SKLO” (GLASS) and serves for throwing of glass pieces (broken glassware, used glass capillaries, remains of glass tubes used when working with melted glass, etc.). Common waste can be thrown also into bins placed on the side of laboratory table rows.

Use fume-hoods when working with toxic or smelly volatile compounds. The fume-hood is a special laboratory table located along a wall of the laboratory, with working space covered by ventilated box with moveable glass front-wall. Fume-hood is connected to tubing system, used for air-sucking of vapours, mould, smoke, toxic gases, etc. out of the building. Similarly to open laboratory tables, also fume-hoods are equipped with inlets of water, burning gas and electricity and connected to water waste system. The switchers for ventilation are located on the wall beside fume-hoods or, alternatively, below working desk of the fume-hood. Switching on the fume-hood is indicated by control blue light beside the switch button.

3.1 Laboratory glass

Glass is the most common material, from which the most of small laboratory equipment (glassware) is made. Reasons are obvious – glass is transparent, and it is easy to watch what is going on in the reaction mixtures. In addition, the glass is also very chemically inert; in fact, only hydrogen fluoride and hot concentrated alkaline hydroxides can damage glass. Disadvantage of the glass is its fragility. Therefore, it is necessary to manipulate with glass equipment carefully to prevent falls or directs. When assembling apparatuses, it is necessary to minimize mechanical stress of all parts. Therefore, some soft material (cork, rubber) should be placed between glassware and metal holders. Glass used for laboratory glassware is a bit more resistant to temperature gradients compared to common (kitchen) glassware, but e.g. soaking of test tube heated by flame into cold water or its steep heating up in flame can lead to its break. Thick-walled vessels cannot be heated. Resistance towards breaking due to thermal gradients is significantly lowered by scratches. Therefore, before the experiment, check if given glassware is not much scratched. Pay special attention if there is a crack. It usually looks like a *spider*. You can work in slightly scratched glassware with a care, but the *cracked glassware cannot be used*.

Wash the glassware immediately after use. If the remaining chemicals are water-soluble, it is enough just to wash the glassware with cold/hot water as necessary, eventually with use of some detergent. Some more resistant dirt can be removed mechanically using a brush. For washing water insoluble material, some small amount of suitable organic solvent can be used. In this practicum, ethanol is enough for such a purpose. Let the washed glassware to dry in air in such position that last drops of water/ethanol can freely flow out.

If terribly dirty glassware should be washed, use of some washing baths (degreasing) is recommended. Pre-washed glassware is dipped into such baths for several hours or days and after this time it is washed by water. Composition of the baths can differ according to character of the dirt. Usually, alkaline baths with some detergent are used, sometimes with suitable chelating agent added (e.g. EDTA), which avoids formation of a scale (and helping to dissolve inorganic metal-based impurities).

Extremely dirty glass can be washed by mixture of concentrated sulphuric acid and 30% hydrogen peroxide, eventually with alkaline solution of potassium permanganate following by washing with hydrochloric acid. These agents are extremely aggressive and it is necessary to work with a high attention and use of protective requisites (thick rubber gloves, protective shield *etc.*). However, they are mentioned for completeness, you will not meet them during work in this practicum.

3.1.1 Ground glass joints

Joints are used to connect several pieces of laboratory glassware. The ground glass joints are precisely ground surfaces which fit and form leak-tight connection. Usually, they have slightly conical shape, and are of two types – *outer jacket (female)*, ground glass surface facing inward, typically inner surface of flask's neck) and *inner core (male)*, ground glass surface facing outward, typically stopper). The most frequently used joints have sizes NZ14 and NZ29 (the number correspond to a top diameter of the joint in millimetres). However, ground glass joints can have also other shapes than conical, *e.g.* spherical (used for example in vacuum rotary evaporators, see [Chapter 3.5.6](#)) or planar (in desiccators, see [Chapter 3.1.14](#)). The joints can be occasionally “*glued*” (the connection cannot be simply disconnected; it occurs often when working with hot alkaline solutions or after work at low pressure). As the glassware equipped with joints is rather expensive, it is reasonable to follow following rules when working with:

Spread joints before a connection by a suitable grease. Most often, Vaseline (petroleum jelly), Ramsay grease (mixture of Vaseline and natural rubber) or silicone grease are used. Spread a male part of the joint (it is enough to “draw” a line along the joint), insert it and turn around the joint axis. Such a move will spread the grease over whole surface of the joint. The grease should not come out from the closed connection. The right spread of the grease will make the joint transparent. The joints should be disconnected as soon as possible after work and should be carefully cleaned from grease remains. If the joint cannot be easily disconnected, try to wobble it through a rubber glove. Sometimes, the joints can be disconnected after careful knocking with a piece of wood. If you were not successful with these procedures, you can heat up the female part with a heat gun or with luminous flame. It will lead to thermal expansion and the inert male part will become free.

Especial care should be paid on spread of valves. Spread grease slightly on sides to avoid plugging of the central hole when moving with the core in a shell.

3.1.2 Test tubes

Test tubes are round-bottomed cylindrical vessels. They have different sizes. The most common are those with inner volume 5–20 ml. The test tubes are used for indicative reactions and trials, for recrystallization of small amounts and for small scale experiments. It is possible to heat them directly by a flame.

3.1.3 Beakers

Beakers ([Fig. 4](#)) are wide cylindrical vessels with plane bottom, often with marks indicating **approximate** volume. They usually have a *beak (spout)* which helps to pour out liquids. The beakers serve for performance of reactions between non-volatile compounds/solutions or for reactions during which some gases are evolved (foam formed in the reaction mixture can be easily disrupted in beakers). The beakers can be directly heated by flame. They can serve for recrystallizations from hot aqueous solutions. Evaporation of water vapours can be lowered by covering the beaked with a watch glass. The beakers can be used for approximate measure of volume, for transfer of liquids/solvents to reaction flasks, but also for weighting of solid

compounds. *The beakers cannot be used for heating of volatile organic solvents.*

Sometimes, tea-kettle-effect occurs when liquid is poured from a beaker (the liquid does not flow directly from the beaker, but it adheres its outer wall and flow on the surface). To avoid such behaviour, a beak can be spread with some grease (Ramsay or silicon grease, petroleum jelly).

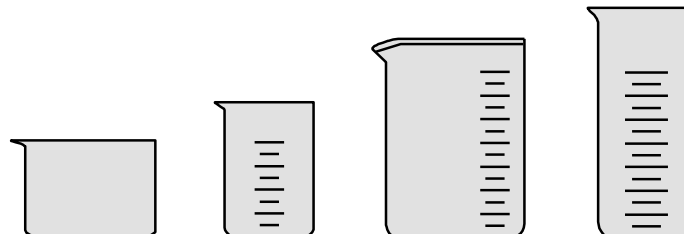

Fig. 4. Laboratory glassware I – beakers.

3.1.4 Flasks

Flasks are the most common pieces of glassware in the chemical laboratory. They are differently shaped according to their primary purpose (**Fig. 5**). Nowadays, their neck is equipped with a joint, but elderly flasks have smooth necks.

Erlenmeyer flasks have conical shape. They can be heated, and their shape influences amount of evaporated solvent, which is significantly lower than from a beaker. The amount of evaporated solvent can be easily lowered by placing a funnel into the flask's neck. The Erlenmeyer flasks can be used as reaction vessels (even for heating of organic solvents; however, it is necessary to equip the flask with suitable condenser). They are suitable for weighing, storage of liquids, or for recrystallizations. They are not suitable for performing reactions, if some gas is evolved with potential formation of foam. Due to a conical shape, such mixture can easily spit out the flask. **Erlenmeyer flasks cannot be used for evacuation** (this is a general rule for all thin-walled glassware with planar bottom) – risk of implosion.

Distillation (round-bottom) flasks are spherical and *it is possible to evacuate them*. *Boiling flasks* have similar shape but they have partly planar bottom and, therefore, *they cannot be used for vacuum works*. Both flask types can be used for performing reactions, distillations and as collectors of distillate.

Pear-shaped, tear-shaped (raindrop) and heart-shaped flasks are usually small (volume up to 250 ml) and are usually equipped with female conically tapered joint NZ14. *It is possible to use these flasks in evacuated apparatuses*, and they are usually used for reactions and distillations.

Titration flasks are similar to boiling flasks, but they have much wider neck, usually without joint. Wideness of the neck enables easy addition of titration agents from the burette (see **Chapter 3.1.18**). The titration flasks are thin-walled, so it is possible to heat them (some special titrations are performed with hot solutions). However, *the titration flasks serve exclusively for performance of titrations* (see **Chapter 4.23**).

Double-necked and flasks with more necks are usually derived from distillation flasks. They are used as reaction vessels in cases, when one neck is not enough – e.g. when reactants are gradually added with simultaneous heating of the mixture under a condenser *etc.* *Flasks with more necks are usually dedicated also for work under vacuum.*

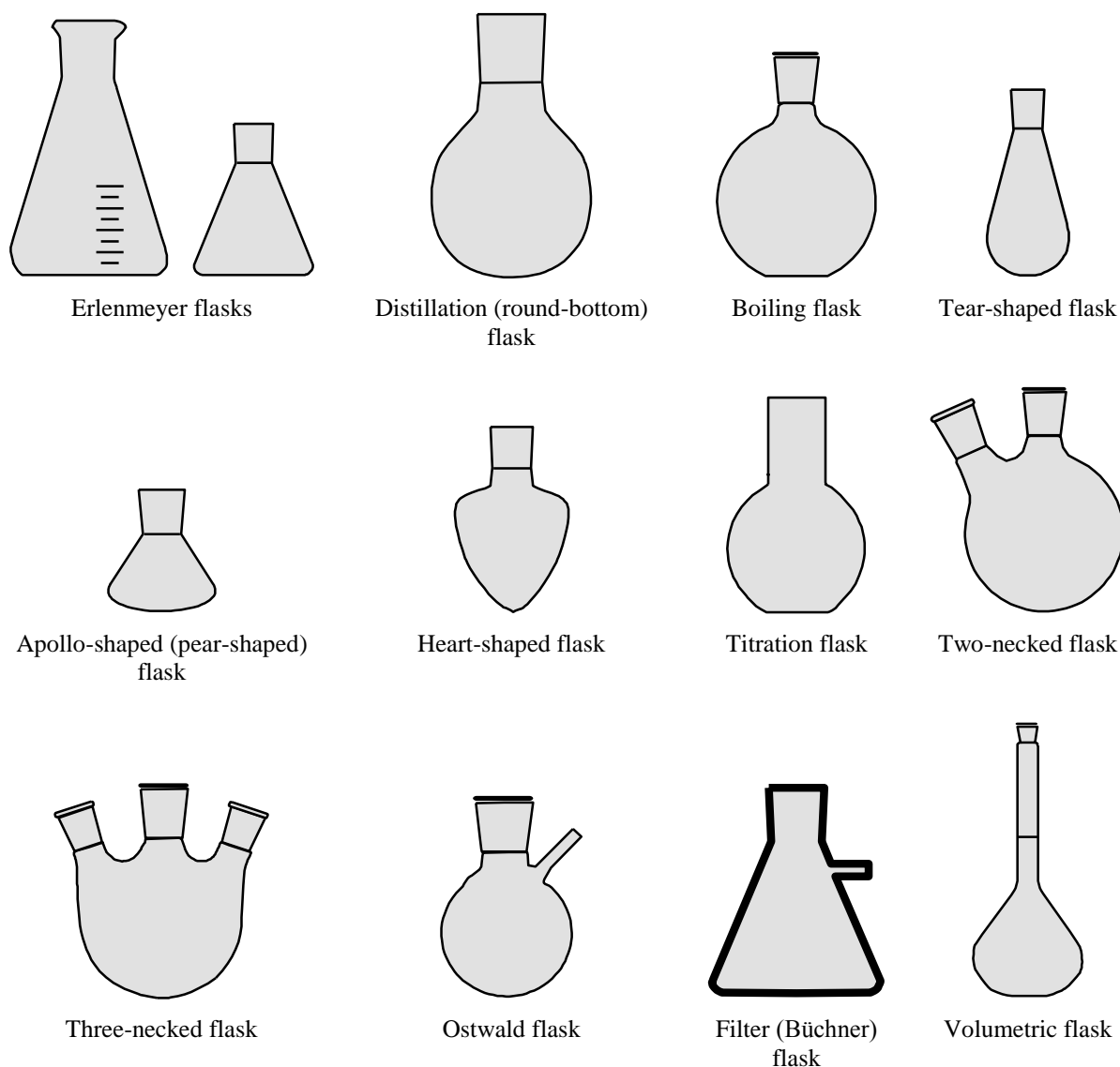

Fig. 5. Laboratory glassware II – flasks.

Ostwald flasks are flasks with very special use. They are equipped with side pipe and serve as vessels for generation of gases, e.g. CO_2 or SO_2 by decomposition of solid carbonates or sulphites, respectively.

Filter (Büchner) flasks are thick-walled conical flasks with side arm. It is dedicated for vacuum filtrations and as all thick-walled glassware it cannot be heated by flame.

Volumetric flasks serve for preparation of stock solutions used in volumetric analysis. They are conical flasks with thin and very long neck with a score line. They are calibrated for filling the inner volume – the score line on their neck shows precise inner volume at given temperature (see [Chapter 4.3](#)). These flasks cannot be evacuated and should not be heated by flame.

3.1.5 Funnels and powder funnels

Funnels ([Fig. 6](#)) are used for pouring liquids into vessels with a thin neck. They can be used also for filtrations (see [Chapter 4.12.1](#)). The funnels can be also thick-walled; such funnels are dedicated (after careful pre-heating e.g. in a drying oven or using a heat gun) to filtration

of hot solutions, when crystallization of the material on the filtration paper could occur during long filtration (when the filtered mixture is gradually cooled down). A special type is ribbed funnel which is mainly used for filtration through folded filter paper. *Powder funnels* (Fig. 6) are used to insert bulk chemicals into reaction flasks without fouling the neck of the flask.

3.1.6 Separating and addition funnels

Separating funnels (Fig. 6) are used to separate immiscible liquids according to their density. They are vessels, usually conical in shape, fitting with a stopper at the top and equipped with a valve with a tube (stem) at the bottom. They may also be used for the slow addition of the reactant solutions to the reaction mixtures. For this purpose, however, there are specially designed *dropping funnels* (Fig. 6), which, unlike the separating funnels, are usually cylindrical, often with a scale indicating the internal volume, and with a pressure equalizing tube. They are also usually fitted with a ground glass joint for mounting on the apparatus.

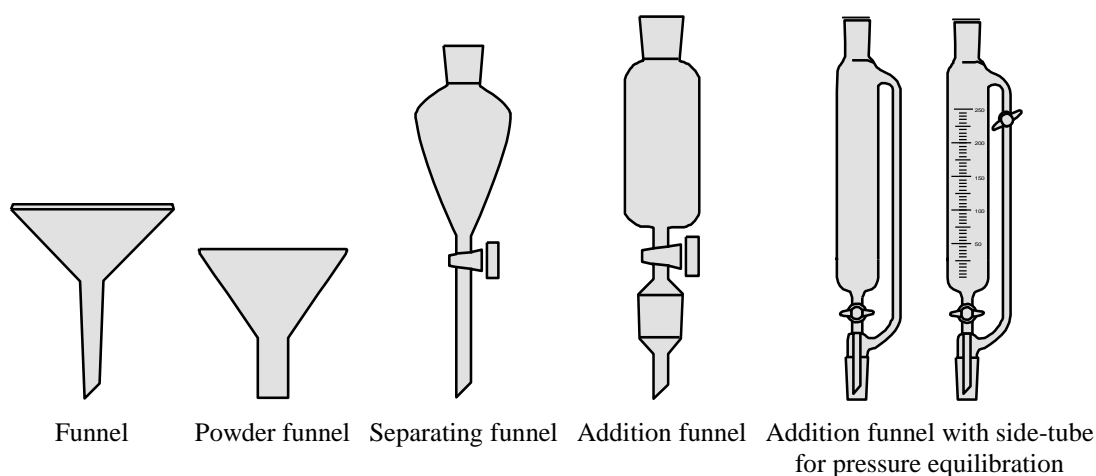

Fig. 6. Laboratory glassware III.

3.1.7 Condensers

Condensers (Fig. 7) are used to cool the vapours of boiling mixtures. If the condensate formed is returned back into the reaction vessel (during *heating to boiling point*), the process is called “*reflux*”, and a *reflux condenser* is used (see Chapter 4.7.3). In distillations (where the condensate is allowed to drip into another vessel) a *descending condenser* is used. A straight condenser is most commonly used as a descending condenser, which is connected to the distillation flask by a distillation adapter and fitted on the other side with a receiving adapter and a distillate collecting flask, eventually with collecting splitter (see Chapters 3.1.8 and 4.14).

The cooling medium is usually water, which circulates through the condenser body. The best cooling is achieved when the cooling water flows from the bottom up; in this arrangement, the entire volume of the cooler is filled with water and heat exchange is most efficient. Therefore, the connection of the cooling circuit should be assembled with care, and the supply hose should always be connected to the bottom pipe of the condenser.

Condensers are of several types, e.g. *straight (Liebig) condenser*, *globular condenser*, *spiral condenser*, *Dimroth condenser* or *finger condenser*. Spiral and Dimroth condensers are the most efficient in terms of cooling, but they are the most difficult to manufacture and therefore the most expensive. In a spiral condenser, the cooling water flows around the spiral and the vapour condensation (and cooling of the reaction mixture) occurs inside the spiral; in a Dimroth condenser, the cooling water flows inside the spiral and the vapour condensation

occurs outside the spiral. Dimroth and finger condensers usually have both the cooling water inlet and outlet pipes located at the top. In these cases, connect hoses to the condenser in such a way that the body of the condenser is full of cooling water.

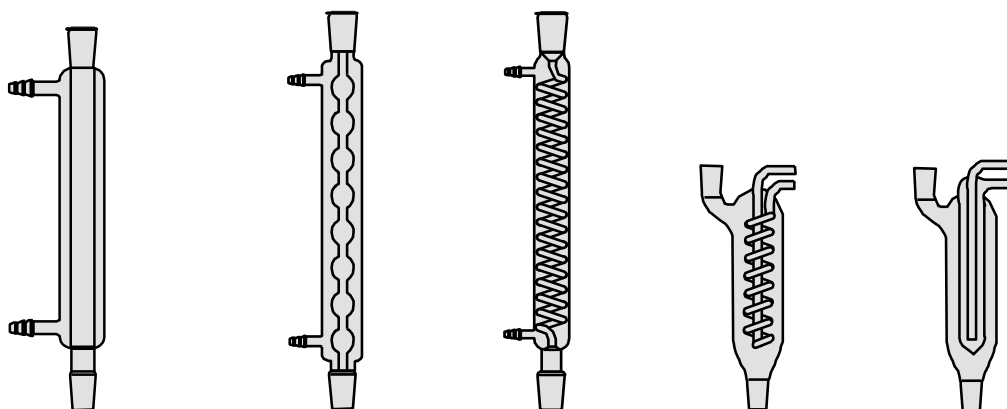

Liebig (straight) condenser Globular condenser Spiral condenser Dimroth condenser Finger condenser

Fig. 7. Laboratory glassware IV – condensers.

There are also various special condensers that allow cooling vapour of boiling liquid using low-temperature mixtures such as solid CO₂ (so-called dry ice) and ethanol.

3.1.8 Distillation and receiving adapters

In distillations, different types of *distillation adapters* are used to connect the distillation flask to the descending condenser (**Fig. 8**). Their top hole is used to insert a thermometer (for accurate measurement of distilled liquid vapour temperature), and a descending condenser is fitted to the side tube.

A *receiving adapter* is mounted on the bottom of the descending condenser during distillation (**Fig. 8**). It serves to direct the flow of distillate into the collecting vessel (beaker, flask). If the receiving adapter is fitted with a joint used to connect it to the collecting vessel, it must be equipped with a side tube to equalize the pressure inside the apparatus with the surrounding atmosphere. This type of adapter can then also be used for distillation under reduced pressure – the tube is used in this situation to connect the apparatus to a vacuum pump (see **Chapter 4.14.1**).

The *collecting splitter* (**Fig. 8**) can be attached to the condenser or the receiving adapter. The splitter allows convenient exchange of collecting flasks without the need to disassemble the apparatus. This is particularly advantageous for distillations under reduced pressure (see **Chapter 4.14.1**). However, you can also meet a distillation apparatus where all the essential elements (distillation adapter, condenser and receiving adapter) are integrated in a single piece of glass.

3.1.9 Tubes with socket and cone (reduction tubes)

Reduction tubes (**Fig. 8**) are used to join pieces of laboratory glass with differently sized ground glass joints. These are glass tubes that have a core at one end and a jacket at the other end. They are most commonly used when attaching small flasks (NZ14) to a rotary vacuum evaporator (evaporators are standardly equipped with an NZ29).

3.1.10 Safety flasks (Woulff bottles)

In cases where vacuum is used, it is often necessary to incorporate a *safety flask* between the

vacuum source and the apparatus itself (**Fig. 8**). Its stopcock serves for quick aeration of the apparatus (*e.g.* in case of sudden rapid spitting of the mixture or foam formation during vacuum distillation, *etc.*), and at the same time the bottle has a protective function for the pump used – it prolongs the path of the distillate vapour to the pump. If a water pump is used as a vacuum source, then the safety bottle protects mainly the distilled substance from water contamination in the event when water pressure in the pipeline drops and the suction of water from the waste into the apparatus can occur.

3.1.11 Bubbles counters, gas washing bottles and cold fingers

When working with gases, *bubble counters* are used to monitor the flow of the gas introduced or developed into/in apparatus (**Fig. 8**). These are small flasks with a tube that reaches below the surface of the inert and non-volatile liquid. A mixture of higher hydrocarbons (paraffin oil), referred as nujol, is often used. Glycerine is also commonly used.

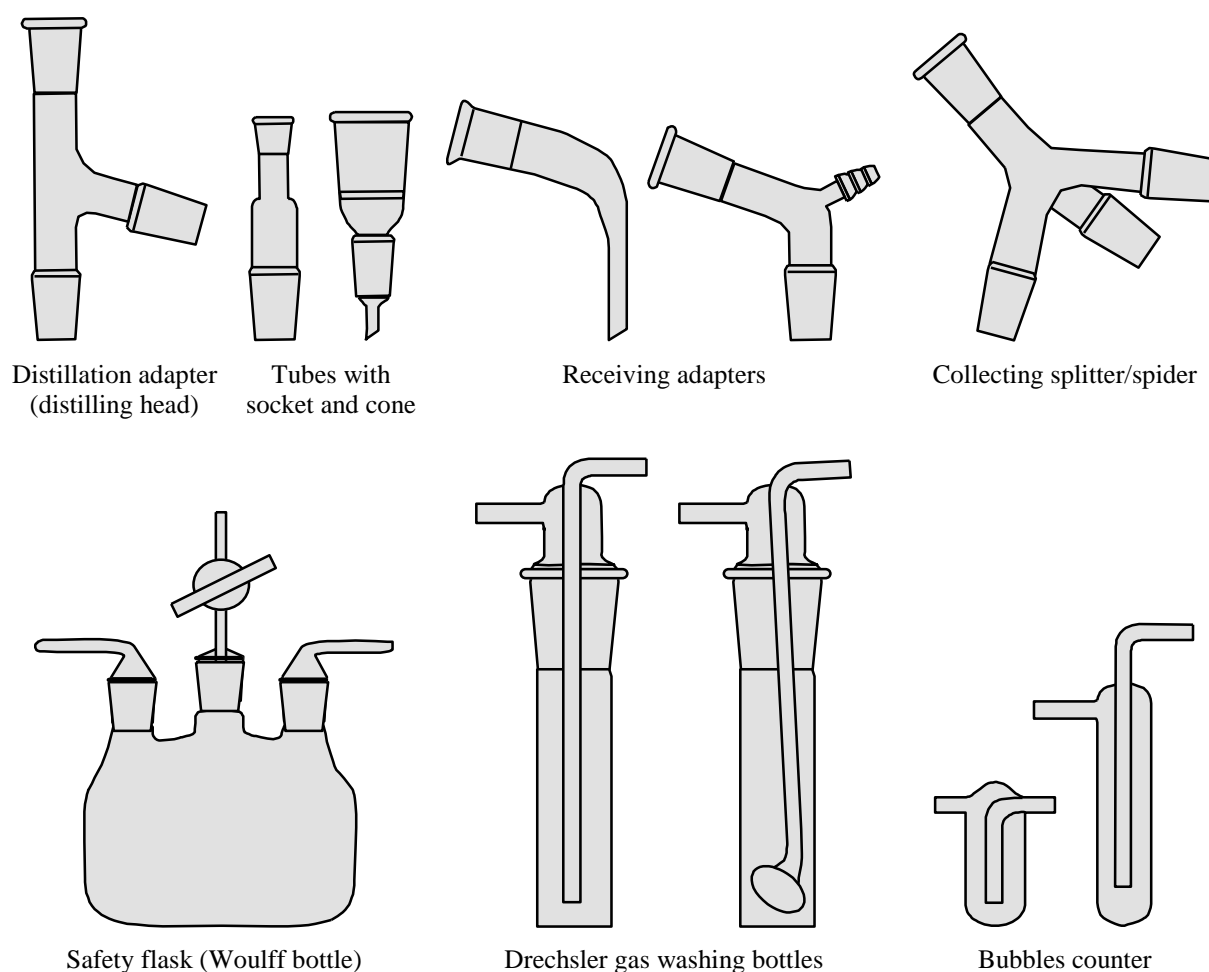

Fig. 8. Laboratory glassware V.

If the used gas must be freed from undesirable impurities or, on the contrary, be saturated with solvent vapours, a *gas washing bottle* is used (**Fig. 8**). It works on the same principle as the bubbler, but is larger, demountable, and its introducing tube is often equipped with a frit at the end to facilitate the dispersion of the gas into the liquid. The liquids used are various chemical agents that bind unwanted impurities from the gas stream; *e.g.* alkaline solutions to remove CO_2 , acid solutions to remove NH_3 , concentrated H_2SO_4 as a drying agent, or reducing solutions to remove traces of oxygen from an inert gas stream (*e.g.* nitrogen or argon).

A *cold finger* (also called a *frost finger*, *refrigerating finger*) looks similar to a gas washing bottle. It is used (after being placed in the cooling bath) to condense the vapours of volatile substances in the evacuated apparatus, therefore it has a round bottom, unlike the washing bottle. It is most often used to protect the oil in vacuum pump from contamination by volatile solvents.

3.1.12 Frits and filtration adapters

Filtration under reduced pressure on a *frit* is used to isolate solid products or to separate by-products. A frit is a thermally sintered powdered/crushed glass, between whose particles the liquid can flow and the solid remains separated on the top (**Fig. 9**). According to the size of the pores between the sintered particles, frits are labelled on the scale S1–S4. S1 frits have the largest pore size and are suitable for filtration of well crystalline materials. In contrast, S4 frits are very dense and can therefore separate even very fine precipitates. They are also suitable for filtration of activated charcoal powder. S2 and S3 frits are usually suitable for isolation of most of materials. The frit can be equipped with a ground glass joint core and a side pipe and can be thus used for direct filtration into a flask of the same size of the joint jacket. However, the production of such frits is laborious and expensive. For this reason, ordinary frits are more commonly used, which are connected to a collecting flask (distillation flask or other flask that can be evacuated) using a *filtration adapter* (**Fig. 9**). This is a tube with slightly conical top with a ground glass joint at lower end and with a side pipe for application of vacuum. A rubber seal must be inserted between the frit and the filtration adapter (see **Chapter 4.12.2**).

3.1.13 Watch glasses, Petri dishes

Watch glasses are used to cover beakers, *etc.* Volatile solvents can be freely evaporated on them from small quantities of solutions/suspensions. *Petri dishes* have similar function whereas they were originally designed for microbiological work – growing cell cultures on growth/culture media. Pairs of Petri dishes of different diameters are also used, the larger diameter dish acting as a cover for the smaller diameter dish and serving for storage or free drying of solids. None of the glassware is designed to be heated directly, they can crack very easily.

3.1.14 Desiccators

The *desiccator* is a thick-walled glass container with a cover; flat contact of the vessel with its lid is equipped with ground glass joint. The desiccator is used for drying of solid materials, *e.g.* products (**Fig. 9**). A suitable desiccant is poured into the bottom of the desiccator. These are usually very hygroscopic substances such as P_4O_{10} , annealed silica gel, solid NaOH or KOH, concentrated H_2SO_4 , *etc.* A container (*e.g.* beaker or Petri dish) with the wet sample is placed on the perforated porcelain plate covering the bottom of the desiccator and the desiccator is closed. The hygroscopic desiccant then reduces the water vapour tension inside the desiccator and speeds up drying of the product. The lid of desiccators is usually equipped with a valve, thus allowing the substances to be dried under vacuum. *The flat ground glass joint between the desiccator and the lid should be periodically lubricated with some suitable grease.* In view of this, when the desiccator is opened, the lid must not be placed in an apparently stable position with the greased surface on the workbench, but in a position resting on the edge of the lid and the valve. When working in pairs, it is best to hold the lid in the hand for the (necessarily long, *i.e.* shortest) opening time.

3.1.15 Thermometers

Thermometers are used to measure the temperature of the baths, reaction mixtures or vapours of the distilled liquids ([Fig. 9](#)). In addition to modern electronic sensors, conventional thermometers based on the thermal expansion of a liquid enclosed in a bulb with a capillary are still much more common. The liquids used in thermometers are mainly mercury, less often gallium or some organic liquids. Thermometers can be equipped with a joint core; they then fit to neck of the apparatuses. They are very fragile and must therefore be handled with care. A particular danger in breaking a thermometer is the possible leak of metallic mercury, the vapours of which are very toxic. Therefore, if the thermometer is broken, the mercury drops must be eliminated (see [Chapter 2.1](#)). Report such accident immediately to the supervisor.

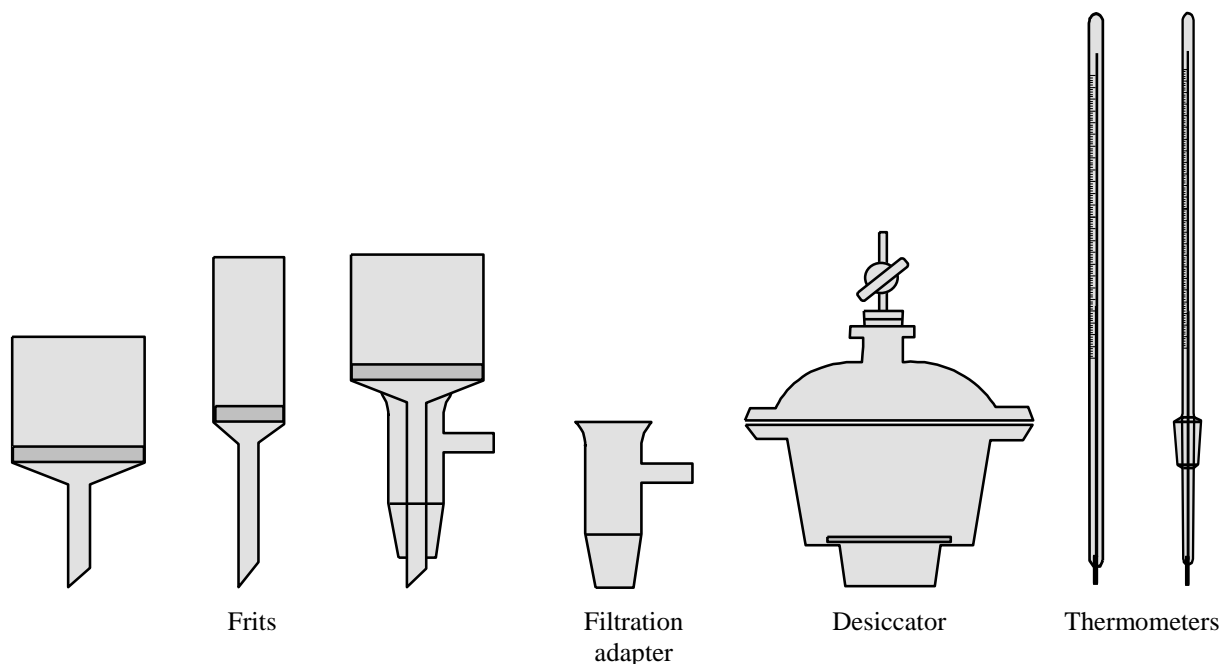

[Fig. 9](#). Laboratory glassware VI.

3.1.16 Volumetric cylinders

Volumetric cylinders ([Fig. 10](#)) are used for relatively accurate measurement of liquid volumes. These are cylinders which have lines on the outside wall to indicate volume. They are used only for measuring volume, not for dissolving substances, heating or carrying out reactions. Do not use them even for dilution of the measured liquids.

3.1.17 Pipettes, Pasteur's pipettes

Pipettes are glass tubes that are tapered at the bottom into a tip ([Fig. 10](#)). They are used for accurate measuring volumes of liquids. For very accurate measurement of a given volume, *undivided volumetric pipettes* are used (especially in volumetric analysis). This is a glass tube that is expanded into a balloon in the middle to accommodate a larger volume. There is a mark in the top part of the pipette which indicates a declared volume of the pipette. In contrast, *graduated (Mohr) pipettes* have the same diameter along their entire length (except for the tip), and the internal volume is indicated as a long-range scale. Pipettes are *calibrated for spillage* – the liquid measured has the declared volume when freely leaks out from the pipette, without blowing out the drop remaining in the tip.

Pasteur pipettes ([Fig. 10](#)) are glass tubes, tapered at the end, on the upper end of which a rubber balloon/bulb is attached. They are used (like plastic droppers, see [Chapter 3.4](#)) to add

small volumes of solution slowly, or to transfer small amounts of liquid.

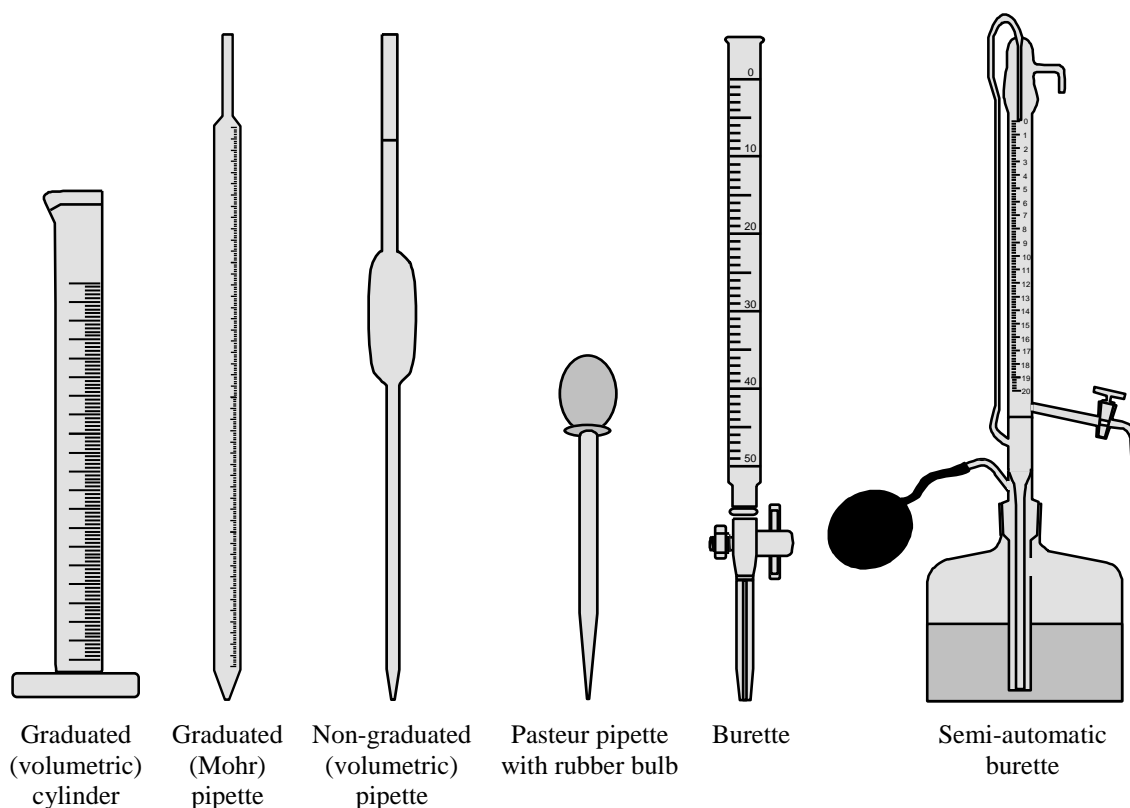

Fig. 10. Laboratory glassware VII.

3.1.18 Burettes

In volumetric analysis, there it is necessary to accurately measure the consumption of titration agent (titrant). *Burettes* are used for this purpose ([Fig. 10](#)). These are accurately calibrated tubes fitted with a valve in the lower tapered section. They are of various types; the simplest ones have to be refilled with titrant after each titration pouring the titrant from above, but semi-automatic types have also been developed where the titrant is pumped by means of a pressurised balloon from a storage bottle on which the burette is mounted. Of course, there are also fully automatized types that are controlled by a PC.

3.1.19 Stoppers

The glass *stoppers* (plugs) are precisely ground to the given standardized size of the glass joint and are used to close the apparatus (flasks, *etc.*). Here again, the warning against “gluing” the joints applies, especially for stuff stored in the flask for a long period of time. Therefore, when closing the flask with a stopper, a suitable lubricant such as petroleum jelly, Ramsay grease or silicone grease should be used. The use of a lubricant is necessary especially when evacuation of the apparatus is planned.

3.1.20 Drying tubes

If it is necessary to prevent air moisture, and possibly carbon dioxide, from reaching the reaction mixture, *drying tubes* are used. These are straight or curved tubes, expanded on one side, often fitted with a joint core for connection to the apparatus (*e.g.* by mounting on a top of condenser). A plug of cotton wool is inserted into the tube, a suitable desiccant (anhydrous granular CaCl_2 , NaOH or KOH pellets, *etc.*) is poured in, and another plug of cotton wool is

inserted against spillage. The drying agent used must not be finely crushed, as in such case it may clog the drying tube. Therefore, the cotton wool used to secure the drying agent against spillage should be inserted only loosely.

3.1.21 Boats for weighing and weighing bottles

For weighing solids on laboratory balances, the *weighing boats* are used. These are small flat-bottomed troughs, open on one side, usually made of glass or porcelain. The boat is placed on a square of paper placed on the balances and the substance to be weighed is gradually added onto it (the paper prevents any spillage of the substance to be weighed onto the bowl of the balances). The boats have the major advantage over the more common weighing on paper that the weighed substance can be washed off, *e.g.* by a stream of water from a washing bottle. Therefore, they are mainly used in analytical chemistry for accurate weighing of samples or standards and for their quantitative transfer (flushing) into *e.g.* titration or volumetric flasks.

Weighing bottles are small cylindrical glass vessels with a ground glass joint cover. They allow a weighing of volatile substances (which would sublime/evaporate during weighing), air-sensitive or hygroscopic substances (which would absorb air humidity when working in air; at normal temperature, air contains about 1–3 % water vapour).

3.2 Laboratory porcelain

Porcelain is somewhat more chemically resistant than glass. It also has a higher heat resistance and can be used to heat reaction mixtures to temperatures higher than 1000 °C. However, it is similarly fragile to glass. Similarly to glass, porcelain does not tolerate fast changes in temperature.

3.2.1 Büchner and Hirsch funnels

The *Büchner funnel* ([Fig. 11](#)) is the porcelain analogue of the frit and is therefore used for filtration under reduced pressure. Typically, the Büchner funnel is used together with the filter (Büchner) flask, and the gap between the two is sealed with rubber plate with a hole. Instead of sintered glass, which separates the solid phase from the mother liquor on the frit, a perforated porcelain plate is used in the Büchner funnel. However, the holes are too large and cannot be used directly for filtration. Therefore, *a circle of filter paper must be always inserted* into the Büchner funnel. This must be of the exact size to fit the flat surface of the funnel and cover all the holes, but not to bend at the funnel walls (see [Chapter 4.12.2](#)). The *Hirsch funnel* is used similarly; it differs slightly from the Büchner funnel in shape, being conical ([Fig. 11](#)). This allows the convenient isolation of even small amounts of solid phase suspended in a relatively large volume of liquid.

3.2.2 Evaporation bowls/dishes

Thin-walled porcelain bowls/dishes ([Fig. 11](#)) with round or flat bottom are used for concentration (thickening) of solutions for crystallization. The advantage is the large surface area of the solution poured into the evaporating dish, which allows the liquid to evaporate more quickly than, for example, from a beaker. Evaporation dishes can be heated from below (typically on a water bath or with a gentle flame).

3.2.3 Mortars and pestles

Mortars are very robust vessels used for crushing and spreading material with a *pestle* ([Fig. 11](#)). The material is spread in them by circular movements of the pestle, not by blows. The mortars must not be heated; in thick-walled porcelain, tensions caused by thermal

expansion in different parts of the bowl can easily occur and cause the crack of the mortar. The mortars with a pestle have inner surface made of unpolished porcelain so that the crushed material adheres well to the surface and can be spread easily. In contrast, for spreading oily mixtures (*e.g.* pharmaceutical preparations), a mortar and pestle with grinding surface covered by thin smooth glazing are used. Grinding mortars and pestles are also made of other materials, *e.g.* chalcedony (agate), stainless steel, *etc.*

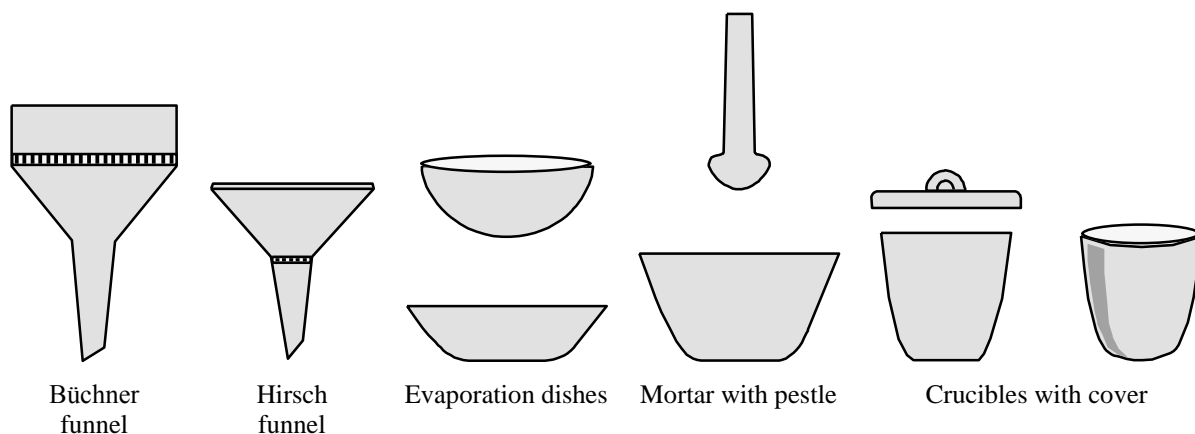

Fig. 11. Porcelain equipment.

3.2.4 Crucibles

Crucibles (**Fig. 11**) are used to perform reactions at very high temperatures, both in a direct flame and in a laboratory oven. After careful preheating, they can withstand very high temperatures. They are also used for analytical purposes (gravimetric analysis). During the work, the crucible with annealed material can be covered with a lid which limits the access of cold air to the annealed material and thus improves the heating of the mixture in the crucible.

3.3 Laboratory metal equipment

3.3.1 Stands

The *stand* (**Fig. 12**) is used for fixing chemical apparatus. Its base is a metal plate (considerably heavy to make the base of the apparatus sufficiently stable) into which a steel rod is screwed. Various holders or rings are attached to the bar of the stand by cross clamps.

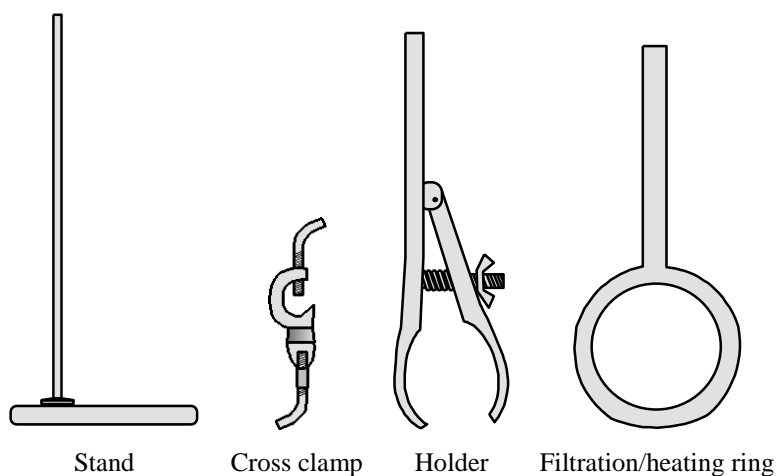

Fig. 12. Metal equipment I.

3.3.2 Cross clamps, holders and rings

The body of the *cross clamps* ([Fig. 12](#)) is provided with two perpendicular cut-outs into which the stand bar and the handle of the *holder* ([Fig. 12](#)) can be firmly fixed by tightening the screw thread. Occasionally, the handles of holders are equipped with a clamp for direct attachment to the stand bar. The holders attached to the stand are used for the attachment of apparatus components. However, glass objects must not be clamped directly by the metal of the holder to avoid breakage. Therefore, the jaws of the holder are equipped with a cork. If the cork insert is missing (*e.g.* in older holder), it is necessary to insert a cut piece of rubber hose between the glass and the jaws. The *rings* (also *filter rings*, [Fig. 12](#)) serve as a support for the ceramic net or triangle when heating of some apparatus with the direct flame of the gas burner is used, or for holding the separating funnels when separating the liquid phases, or for holding the funnels during filtration.

3.3.3 Burners

The different types of burners ([Fig. 13](#)) differ mainly in the way how air is mixed with the combustible gas. The gas burns with a non-luminous flame after controlled mixing with air and such flame reaches a much higher temperature than the luminous flame. The oldest type of burner is the *Bunsen* one, while newer types include the *Teclu* burner (which is very rare in practice) and the *Méker* burner. In both Bunsen and Méker burners, the air supply is controlled by turning a perforated ring at the base of the burner. The ring then covers/uncovers the holes in the tube of the burner. In Teclu stove, air access is controlled by a flat disc that moves up/down to change the size of the slit.

Non-luminous flame occurs if the air intake slots are open, while a luminous flame is created by closing the air intake slots. The flame is luminous by microscopic particles of soot produced by imperfect combustion which is why a non-luminous flame is clear as opposed to a luminous flame, when soot is deposited on heated surface.

Always light the burner with the air inlet closed to avoid the risk of the flame inside the pipe of the burner (often accompanied by a loud sound effect called “barking”). If this occurs, the flame cannot be controlled and the burner body will heat up to a high temperature and can be a source of burns and/or fire. So in such case a burner must be extinguished immediately, allowed to cool down and then relighted correctly with the air supply closed.

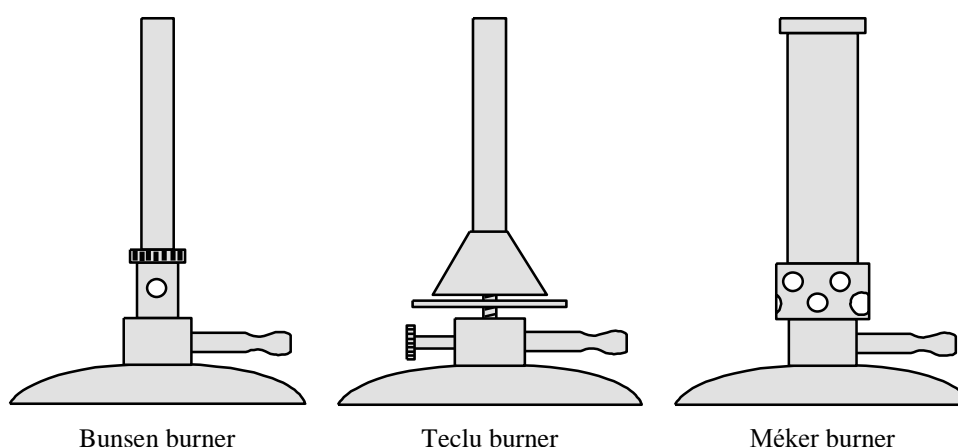

[Fig. 13](#). Metal equipment II – burners.

When heating with a flame (*e.g.* when melting glass) it must be remembered that not all areas of the flame are at the same temperature. While the temperature of the blue sword inside the non-luminous flame ranges from about 300 °C (at the bottom) to 550 °C (at the tip), the temperature in the surrounding flame (even just above the central sword) is usually around

1550 °C. When working with glass, therefore, keep the molten part just above the central sword, where the temperature is highest.

3.3.4 Boiling tripods, ceramic nets and triangles

The *tripod* (Fig. 14) consists of a metal rim with three legs. It is designed for heating over the burner (together with a ceramic net or triangle), but does not allow adjustment of the height of the heated object above the flame. *Wire nets* (Fig. 14) usually fitted with a ceramic fibre target are placed on rings or tripods. Nets with asbestos target were formerly commonly used, but because of carcinogenicity of asbestos they are no longer used in practice; however, the term “asbestos net” persists in laboratory slang. The use of a net is necessary when heating substances in glassware (beakers, Erlenmeyer or boiling flasks, *etc.*) over a flame. The *triangle* (Fig. 14) is made of three steel wires threaded through ceramic tubes. The triangle, like the net, is placed on a ring or tripod and the crucible with annealed material is inserted into the triangle.

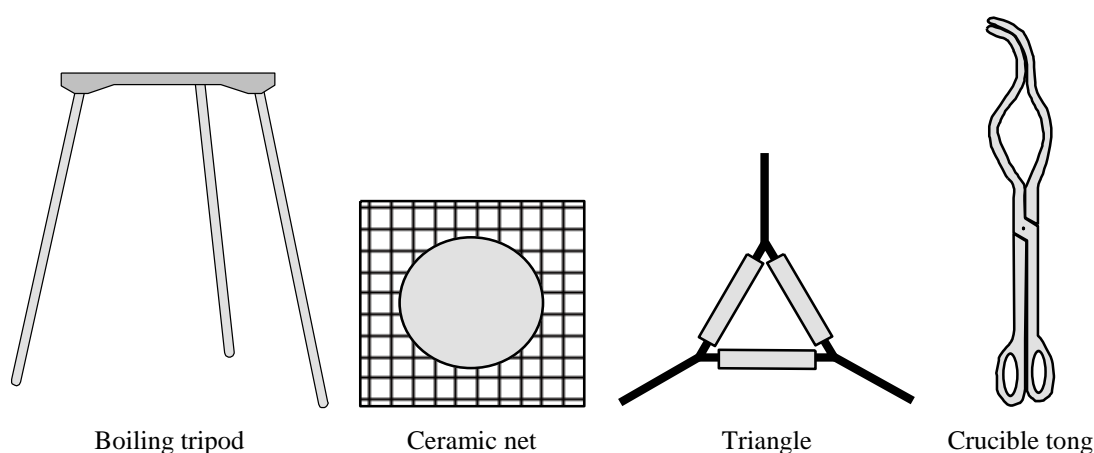

Fig. 14. Metal equipment III.

3.3.5 Crucible tongs, pincers and spatulas

The *chemical tongs* (Fig. 14) are used to grip hot objects (*e.g.* when removing hot crucibles from a flame or an oven). *Tweezers* are usually made of stainless steel. They are used to handle small objects that are harmful to a touch of the fingers (*e.g.* small weights) or where injury could occur (removing stirrers and cooking stones from filtered preparations, sealing ampoules, *etc.*). The *spatula* is usually also made of stainless steel and is used for handling small quantities of solids (*e.g.* for pouring, weighing, *etc.*).

3.4 Laboratory equipment made of plastic, cork and rubber

The most common plastic items in the chemical laboratory are *stoppers*, *washing bottles*, *droppers*, *spoons* and *syringes* (Fig. 15). Plastic is a chemically very resistant material, but it usually does not tolerate heating to temperatures close to 100 °C – therefore, plastic items must not be dried in ovens.

Plastic stoppers usually have standardized dimensions and therefore seal well in ground joints of flask necks. Compared to glass stoppers, they usually do not “glue” to the joint and, therefore, there is no need to lubricate them. However, they are not leak-proof in the long term and therefore cannot be used to seal volatile mixtures or substances susceptible to oxidation by air for long term storage.

Washing bottles are plastic bottles with a tube in the cap ending in a jet. This is connected to a tube extending to the bottom of the bottle. When the bottle is squeezed it squirts the liquid

from the jet. The washing bottles are usually filled with distilled water or some organic solvents (most commonly ethanol or acetone, but also others). They are used to wash laboratory glassware or to quickly add solvents to reaction vessels and/or to dilute solutions.

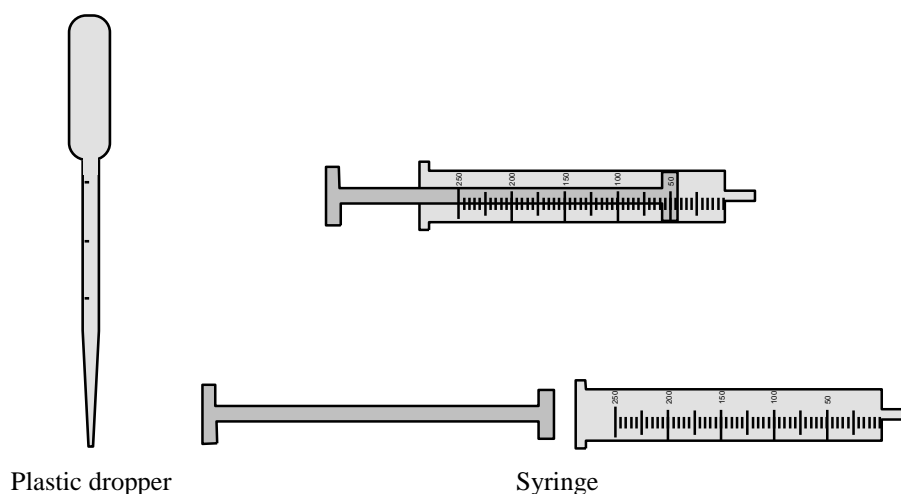

Fig. 15. Plastic equipment.

Plastic droppers are analogous to Pasteur pipettes. In contrast, they are more difficult to wash out and cannot be used to work with very hot solutions. In addition, they can become softened by the action of some organic solvents which extract the fillers from the plastic material. They are therefore particularly suitable for working with aqueous solutions, and can easily withstand concentrated acids and alkalis.

Spoons are used when handling solids. They are not very mechanically resistant, so they are not suitable for crushing chemicals that are baked into large lumps in the storage bottle - in this case, the large lumps need to be broken with a suitable metal rod (spatula).

Syringes are used to measure small volumes of solvents/solutions relatively accurately. Together with needles and septa they are the basis of techniques that allow work on the microscale (see [Chapter 4.22](#)) or with air-sensitive chemicals. Working with syringes also reduces the evaporation of unpleasant (odorous) substances into the laboratory atmosphere if you have to work with such substances outside the fume hood.

Cork is a material obtained from the bark of the cork oak tree. It is light, flexible, quite resistant to elevated temperatures (but flammable) and easy to work. However, like most biogenic materials, it is not resistant to strong acids and bases (nitric acid, sulphuric acid, alkaline hydroxides) and halogens, but is resistant to organic solvents. In addition to the previously mentioned jaws of the holders, it is mainly used for the production of stands (pads) for round-bottom flasks. However, its former use as a material suitable for stoppers (which could be further modified, *e.g.* drilled, without any problems) has been overcome by the ground glass joints.

Rubber, unlike cork, resists alkalis, but also does not resist strong acids and halogens. In addition, it partially dissolves and swells in organic solvents. Rubber is mainly used to make hoses, but it loses its elasticity as it ages, so it must be checked from time to time to see if it is still elastic and replace it if necessary. Thin-walled rubber hoses are used for water and gas lines, while thick-walled vacuum hoses are used for work under reduced pressure (vacuum), *e.g.* for connecting apparatus to a vacuum pump. Rubber plugs have the advantage over cork plugs that they seal well.

Special chemically resistant rubbers (*e.g.* silicone rubber) are used to make septa. These are used to seal the apparatus against the access of air oxygen. They can be pierced (even repeatedly) with needles and serve for addition of reactants or solvents to the sealed mixtures

(e.g. under an inert atmosphere) by means of a syringe.

3.5 Laboratory instruments

3.5.1 Stirrers, (magnetic) heating plates and heating nests

Today, *magnetic stirring bars* are most commonly used for stirring of the reaction mixtures. A magnetic stirring bar is an iron rod (or permanent magnet) sealed in a glass tube or enclosed in a Teflon sleeve. It is set in motion by the rotating magnet of the *magnetic stirrer*.

The *heating plates* are used to heat mixtures. These are “electric cookers” using resistance heating. However, an elegant technique is to stir with a magnetic stirring bar while heating. Heating plates are therefore usually designed in such a way that a rotating magnet is placed under a metal heating plate, and the frequency of rotation of the magnet can be varied independently of the heating of the plate.

Heating nests can be used to heat the round flasks. These can only be used for flasks of the appropriate size; nests are available for heating flasks from 50 ml to 6 l. Heating nests are very suitable for heating larger volumes of solvents (see [Chapter 4.14.2](#)).

3.5.2 Balances

Balances are used to determine the weight of substances. Today, most common are digital balances. Compared to the older mechanical types, they have the advantage of working very quickly, and they allow tare (*i.e.* resetting the weight of an object placed on the balances, especially a paper, boat, beaker or other vessel into which you weigh), which also speeds up the work very much. It is usually sufficient to know the weights of the individual reactants or products with accuracy ± 0.005 g. This is the precision to which “normal” *laboratory balances* works. For more accurate weighing, *analytical balances* are used. These work to four or five decimal places on the gram scale. In order to limit error of the balances caused by air flow in the room, analytical balances are equipped with a glass box in which the balance bowl is enclosed. For accurate work, the balance must be placed on a very solid (immovable) base, which is realized, for example, using a stone slab, placing the balance on a special panel cemented into the wall, *etc.* The recommendations for weighing are given in [Chapter 4.2](#).

3.5.3 Sources of electric current

Various *DC voltage sources* are used for electrochemical preparations, as for example plating. These are various types of transformers on which either the voltage applied to the electrodes or the electric current flowing through the circuit can be continuously adjusted by a potentiometer. The power supply is often equipped with a display showing actual value of the quantity (voltage, current); in older types the display is usually mechanical (a hand with a calibrated scale). Very often the power supply has only one potentiometer and one display. Depending on the position of a special switcher, the display shows either voltage or current, which is adjusted to the desired value by slider of the potentiometer/rheostat.

When the power supply is switched on (and electric current is therefore flowing through the apparatus), *the contacts of the connected wires must never be touched*. You must keep your hands dry when working with the electrical circuit.

3.5.4 Sources of vacuum

Low pressure (vacuum) is obtained by using an *oil* or *diaphragm pump* or a *water pump* ([Fig. 16](#)). While the diaphragm pumps are based on mechanical oscillation of the diaphragms and the vapours passing through the pump do not influence their function too much, the oil pumps circulate high boiling oil which must be protected from contamination. This is best

done by use a freeze finger between the pump and evacuated apparatus (see [Chapter 3.1.11](#)). The principle of the water pump is based on the *hydrodynamic paradox* – *i.e.* the fact that the pressure in the flowing fluid is *inversely* proportional to the velocity of the fluid. Thus, there is lower pressure in the jet part of the tube where the water flows faster (implied by a simple modification of *Bernoulli equation*). However, the use of water pumps has now been abandoned because of their enormous water consumption. In addition, the vapour of toxic volatile substances (organic solvents) can potentially contaminate a wastewater. However, if you are going to use a water pump, it is a good idea to open the water valve to maximum to assure a full speed of water; this will avoid the possibility of water being drawn back from the sink into the apparatus/evaporator when the water flow in the pipework suddenly drops (in such case, there would be a lower pressure in the evacuated apparatus than in the pump). The theoretical limit of the vacuum achieved by water pump is the equilibrium pressure (tension) of the water vapour, which is at common temperature approximately 2–3 kPa (15–23 Torr).

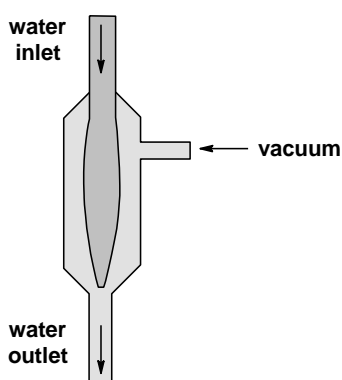

Fig. 16. Scheme of water pump.

Switch off water and oil pumps only after they have been disconnected from the apparatus (*i.e.* after they have been aerated). This prevents water or oil from being drawn into the apparatus. Switch off also diaphragm pumps after they have been aerated – if they are switched off under vacuum, any condensate or aggressive gases will remain in them and may cause some damage.

Never connect the vacuum source directly to the apparatus, but always place a safety bottle (see [Chapter 3.1.10](#)), a freeze finger, a gas washing flask (see [Chapter 3.1.11](#)) or at least a tube with a valve allowing the apparatus to be quickly aerated and disconnecting of the pump.

3.5.5 pH-meter

A pH meter is a sensitive voltmeter that measures the change in *potential (voltage)* between electrodes. In the case of pH measurements, the most commonly used electrode is the *combined glass electrode*. The electrode has to be handled with particular care as it has a thin-walled glass bulb at the bottom which is not very resistant mechanically.

A description of procedure for measuring pH with the pH meter can be found in [Chapter 4.6](#). Detailed instructions for using the pH meter can be found on the working place.

3.5.6 Vacuum rotary evaporator

A *rotary vacuum evaporator* is used to evaporate solvents from the reaction mixture or chromatographic fractions ([Fig. 17](#)). Inside the rotating flask, a film of solution is continuously generated on its walls and is evaporated by the application of vacuum. Therefore, a rapid concentration increase (thickening) of the solution occurs below the boiling point of the evaporated solvent (*i.e.* without bubbling and spitting of the mixture). Membrane

pumps are almost exclusively used as vacuum sources for vacuum evaporation.

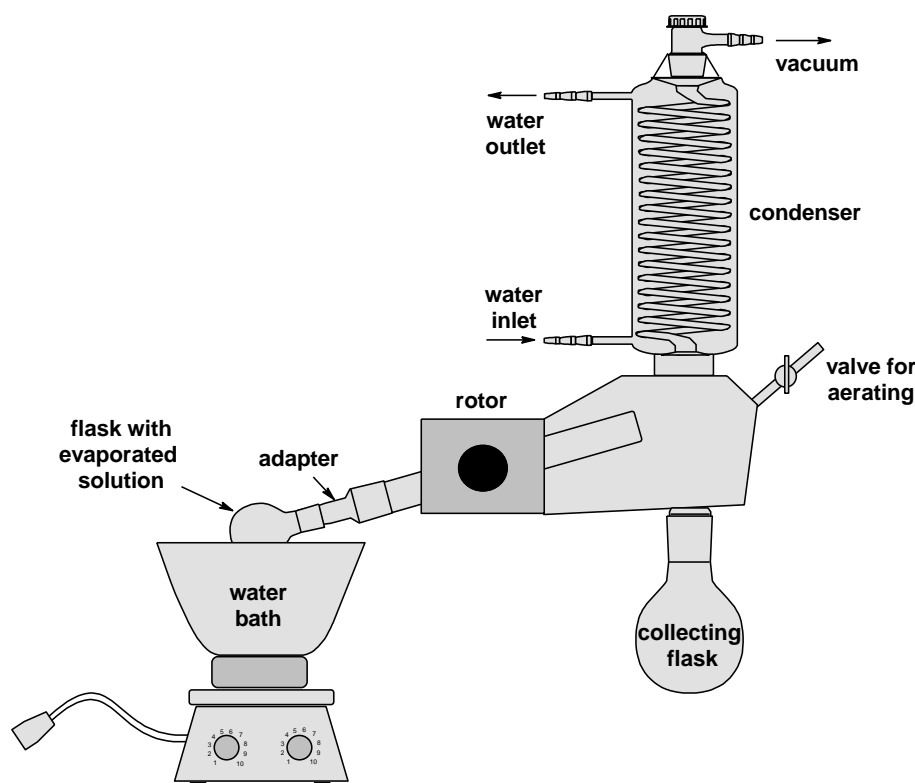

Fig. 17. Vacuum rotary evaporator.

3.5.7 Melting point apparatus

A very important characteristic of solids (especially of their purity) is the melting point. As the melting point apparatuses, simple glass vessels filled with a liquid of suitable heat capacity (*e.g.* oil) were used in the past for substances with low melting point (below 120 °C). For substances with higher melting points, well heat conducting metallic blocks were used. Nowadays, fully automated electrically operated devices are used which you will also use in this practicum.

In a typical melting point determination a small sample is packed in a thin-walled glass capillary and the capillary is placed in a heated bath of the device. The display of the device shows the current temperature of the bath and at the same time you can observe the capillary with the substance with a magnifying glass until it melts. Detailed instructions for the use of the melting point determination device can be found on the working place.

An alternative to the use of capillaries is the micro-heating table (Kofler block). This is an electrically heated plate placed under the microscope. The electrical input for heating of the plate is controlled by a rheostat, and at the same time the temperature of the stage is measured by a mercury thermometer, the scale of which is shown in one half of the field of view of the microscope. In the other half of the field of view the particles of the sample are monitored. The consumption of studied material is minimal due to the microscopic design. However, a micro-heating stage is not used in this practicum.

3.5.8 Refractometer

A device for determination of the refractive index is *refractometer*. The most commonly used type in practice is the double-prism *Abbe refractometer* (**Fig. 18**). This type of refractometer is designed to measure the refractive index of liquids. Its core is made of two prisms

(illuminating prism and measuring prism) made of Iceland limestone. The measured liquid is poured between the walls of the prisms and spread in a thin layer over entire contact area of the prisms. When measured in transmitting light, the light enters the illuminating prism through the wall and, after scattering on its roughened surface, enters the measured liquid in all directions and refracts. In the field of view the interface given by the cut-off rays emerging from the measuring prism can be observed, if axis of eyepiece is rotated appropriately (the position relative to the prisms is controlled by a micrometric screw). The scale of the device is marked directly in the refractive index values. The measurement is performed using typically the wavelength 589.3 nm (the average value of the wavelengths of the spectral lines of the doublet D of sodium lamp, $\lambda = 589.0$ and 589.6 nm, respectively), which is the most commonly used lamp in refractometers. Detailed instructions for use of the refractometer can be found on the working place.

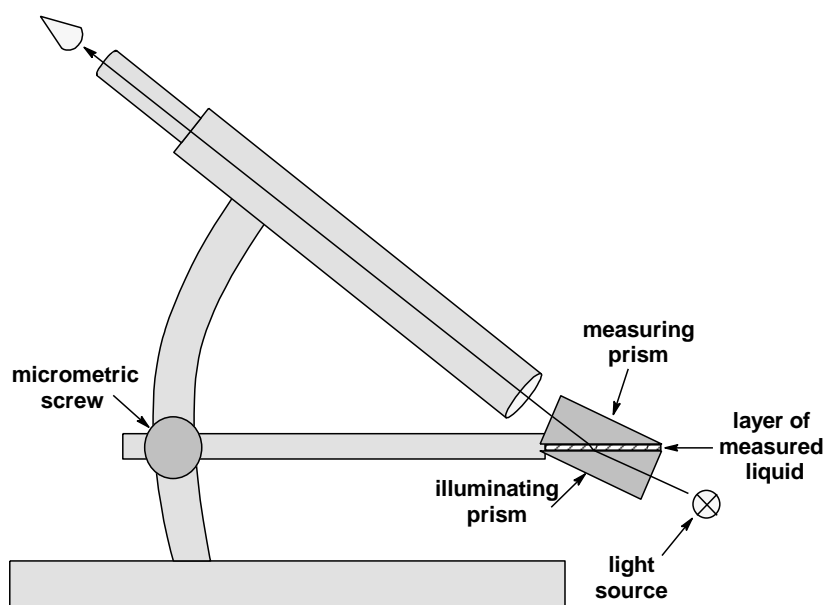

Fig. 18. Scheme of refractometer.

3.5.9 UV-Vis spectrophotometer

The function of the devices for measuring electron absorption spectra – *i.e. spectrophotometers* – is obtaining monochromatic radiation and measure the change in its intensity after passing through the solution of the substance under investigation. The basic elements of spectrophotometers are a light source, a monochromator, a cuvette holder and a detector. Spectrophotometers can be arranged in a single-beam or double-beam fashions (**Fig. 19**).

In a *single-beam* spectrophotometer, the so-called “blank” (a solution for comparison, usually a pure solvent) is measured first. The radiation from the source passes through a cuvette containing the comparison solution, where it is somewhat attenuated (by reflection off the walls of the cuvette, absorption by the solvent or other components of the solution) and strikes the detector (usually a photocell). The resulting photoelectric current is measured and assigned to absorbance value of zero. After replacing the cuvette with blank with a sample cuvette, the absorbance of the unknown sample is then measured.

In a *dual-beam* spectrophotometer, the beam passes through both the measured and the comparison sample. After exiting the monochromator, the beam is divided by a rotating mirror alternately into the measuring and comparison cuvettes. After exiting the cuvettes, both beams are guided by the mirrors to the detector, which detects the transmitted radiation

intensity in each cuvette.

In spectrophotometers, the monochromatic radiation is obtained after dispersion through a prism or a diffraction grid. A deuterium lamp is most commonly used as a source of continuous radiation in spectrophotometers for the ultraviolet region. For the visible region, tungsten or halogen lamps are used.

The absorbing medium is a liquid sample placed in a special container – a *cuvette*. The basic condition for the cuvettes is that the material from which they are made does not absorb radiation in the wavelength range of interest: quartz cuvettes are used for the UV-visible region, while glass or plastic cuvettes can be used only for the visible region. The cuvettes for spectral measurements are sensitive to mechanical damage and, therefore, they should be filled with a care, optimally using a plastic dropper.

Detailed instructions for the use of the spectrophotometer can be found on the working place.

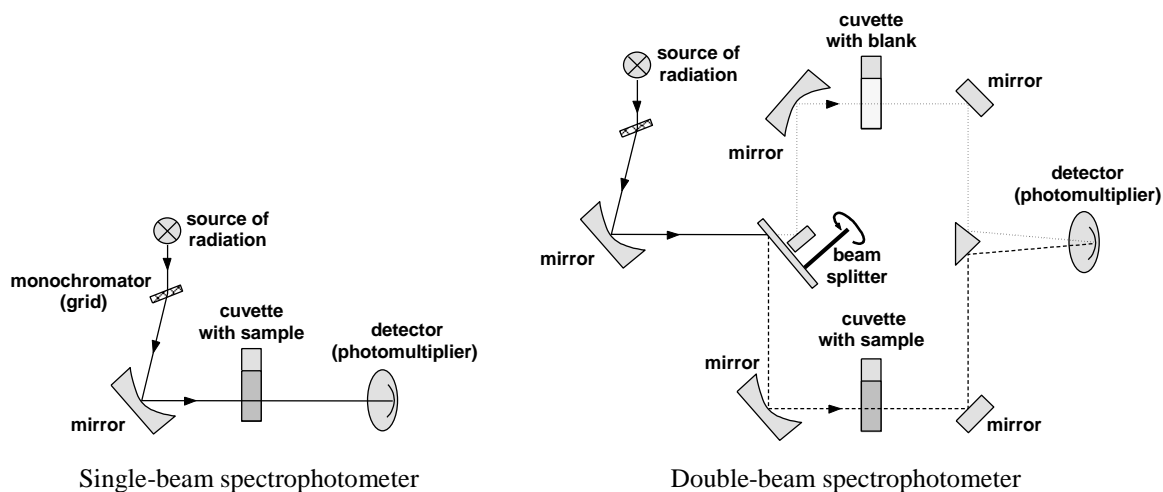

Fig. 19. Schematic representation of basic types of spectrophotometers.

3.5.10 Laboratory furnace

Electric furnaces/ovens are used to heat substances to a high and defined temperature. These are chambers with resistance heating in which the temperature is regulated by the power input. Modern types are programmable and allow defined heating and cooling (setting of heating/cooling speed, heating time at a given temperature, *etc.*).

3.6 Chemicals, drying agents and solvents

Chemicals used for reactions (*reactants*) are stored in storage bottles. The name (or formula) of the chemical and its purity (or concentration) must be clearly written on them. The labels on commercial chemical bottles often state basic characterisation data for the chemical, *e.g.* molar mass, melting point for solids or boiling point, density and refractive index for liquids. Always use only clean equipment (spatulas, spoons, syringes, droppers, *etc.*) to scoop and substances from storage bottles. Close the storage bottle carefully as soon as the required amount of chemical has been taken. Take only the amount of substance you will need for your experiment.

Substances that have an ability to remove water from their vicinity, *e.g.* by hydrate formation, chemical reaction with water or simple adsorption, are used as *drying agents*. To dry solutions in organic solvents, anhydrous inorganic salts are often used, which form a crystalline hydrate (*e.g.* Na_2SO_4 , MgSO_4 , CaCl_2). In desiccators, P_4O_{10} is often used which reacts with water to form the polymeric phosphoric acid $(\text{HPO}_3)_x$. Alkaline hydroxide pellets are also suitable for filling of the desiccators. These also remove CO_2 from the atmosphere. Concentrated H_2SO_4

is also an excellent desiccant, but the liquid filling makes the desiccator somewhat difficult to handle. For the drying process, annealed *silica gel* or *molecular sieves* are also often used. Molecular sieves are chemically aluminosilicates (zeolites) with a crystal lattice forming defined cavities, which have a characteristic size for each type of molecular sieve, and into which small molecules (*i.e.* water, but also *e.g.* methanol, *etc.*) bind selectively. They have the advantage of high capacity, the possibility of regeneration by annealing, and high chemical inertness. Their inertness allows a drying of the solvents by pouring the annealed molecular sieve into the solvent bottle and standing for a long time, or by binding the water formed during the reaction directly in the reaction mixture.

Solvents are very important for carrying out of the chemical reactions. A solvent is a liquid substance that is usually not directly involved in the given chemical reaction, but whose presence is necessary for the successful progress of the reaction. The most important role of the solvent is to dissolve the original reactants allowing them to react with each other. In contrast, if the solid reactants were simply mixed, no reaction would take place because diffusion in the solid state is negligibly slow and the individual reactants would therefore not meet at the molecular level. Furthermore, solvents are used in crystallization, extraction, chromatography, *etc.* The cheapest and most common solvent in inorganic chemistry is water. Often, however, water is not suitable as a solvent, especially for organic reactions, since it does not dissolve most organic substances and the presence of water (even of trace amounts) even disrupts many organic reactions. It is then necessary to use suitable organic solvents. Even very “exotic” substances such as HF, NH₃, SO₂ or supercritical CO₂ can act as solvents. The latter solvent is a frequently used (and often irreplaceable) extracting agent in industry; it is used in huge quantities, *e.g.* for extracting caffeine from roasted coffee.

4. Basic laboratory procedures

4.1 Assembly of apparatus

When assembling some complex apparatus, it is necessary that the apparatus is placed above the metal plate of the stand (and not from the side or even from the back – in such case there is a risk of tilting of the stand with the apparatus). Assemble the apparatus from the bottom to up. The lowest part of the apparatus (most often the reaction flask) must be firmly fixed with a holder tightened at the point of the flask neck, but not too tightly (risk of breaking the glass). It is also necessary to avoid direct contact between the metal of the holder and the glass of the flask. The holders usually have a cork insert; if this is missing, pieces of cut rubber hose threaded on the outside of the neck of the flask serve for the same purpose. The other parts of the apparatus need not be attached. The use of a second holder is necessary only in the case of heavy or large apparatus, *e.g.* with heavy (descending) condenser, *etc.* However, these other parts of the apparatus must not be firmly attached, but only secured (held only loosely). In distillations where the weight of the descending water-filled condenser is high and brings a risk of breaking the glass, the cooler must be supported by attaching to another stand.

When attaching the *holder handle* (rod) to the cross clamps, the cross clamp *must always be oriented so that the handle fits into the clamp from above* (Fig. 20).

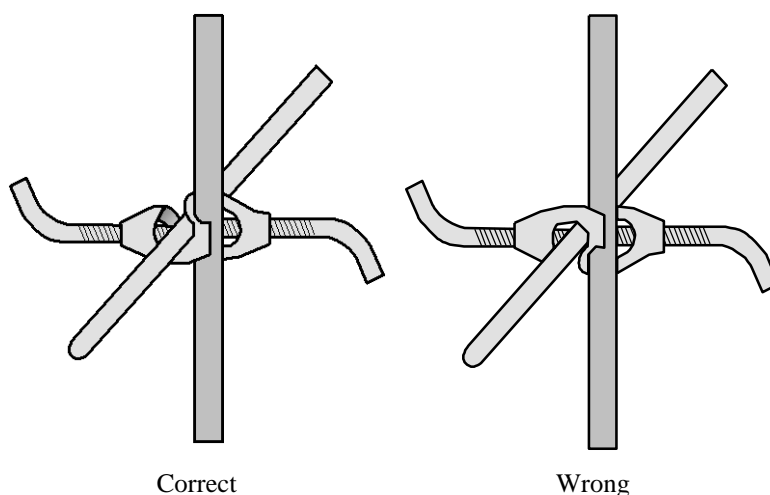

Fig. 20. Attachment of the holder to the stand using the cross clamp.

If the apparatus will be heated in a bath on a magnetic heating plate, it is preferable to support the heating plate with a lifting platform (telescopic base). This arrangement allows to quickly interrupt the heating (if some unexpected events occur, *e.g.* overheating of the mixture, initiation of an exothermic reaction, *etc.*) by moving the heating plate with the bath downwards.

4.2 Weighting

In practice (and in this practicum) you will most often use digital balances that allow so-called tare (zero weight setting). Place the empty vessel into which you will weigh the substance on a piece of paper placed on the surface of the balance and press the “TARE” button. This will recalibrate the zero weight and you can then weigh without counting the weight of the empty vessel. Use *common balances* for weighing of reactants or products for which the weights is not needed to be known exactly. Beakers are suitable for such weighting. If you will be preparing samples for analytical determinations or working with very small

amounts of chemicals (in the order of tens/hundreds of milligrams), use *analytical balances*. Glass or porcelain boats are most often used as vessels, from which the weighed substance can be conveniently flushed out *e.g.* with a stream of water from a washing bottle. This so-called *quantitative transfer* (rinsing) into *e.g.* titration or volumetric flasks is used in analytical chemistry when handling with precisely weighed samples or standards. Alternatively, so-called *differential weighing* can also be used. This is done by first determining the weight of the vessel containing the chemical (or sample) and then, after it has been poured into *e.g.* a titration flask, determining the weight of the empty vessel including any residues of the substance adhered on the walls. The difference between these values is equal to exact amount of the substance/sample that has been poured off. The advantage of this approach over standard quantitative rinsing is that the vessel does not have to be dried before further weighing in repeated experiments/determinations.

When weighing on analytical balances, it is necessary to close the glass box of the balances – this will reduce airflow that can cause fluctuation of the balances precision. If possible, do not touch the weighed object with your fingers during precision measurements – sweat or any dirt on your hands also play a role in the accuracy of the weighing.

The balances can also be used to measure amount of liquids. Liquids can be successfully weighed in closed syringes; larger quantities of non-volatile liquids can also be weighed in open vessels (*e.g.* beakers).

Never pour the weighed substance directly onto the bowl of the balances. Always use a suitably large piece of filter paper or, better, a piece of smoothed paper (*e.g.* paper from a catalogue of chemical suppliers is very suitable), or a suitable vessel (beaker, boat, weighing bottle), but do not place it directly on the balances, but also on the paper, to prevent the balances from contamination by spillage. If the weighed substance was spilled, the balances must be cleaned immediately, *e.g.* with a brush, or the balances must be disassembled and their bowl washed and dried. However, do not do this yourself but ask the supervisor for the help.

4.3 Measurement of volume

For approximate measurement of the volume, *beakers* with orientation lines are usually sufficient. More accurate volume measurements can be made with *cylinders*, and the most accurate with *pipettes*, *burettes* and *volumetric flasks*. In these cases, fine scratched lines are used to mark/read the volume. Due to the surface tension of liquids, the liquid surface is not straight, especially in narrow pipes, but is curved into a so-called meniscus. As the reaching of the line marking the given volume the situation where the lowest point of the meniscus is touching the plane of the line is considered (see [Fig. 21](#)).

Measurement of volumes in the millilitre to litre size range is carried out using a graduated *cylinder*. The volume is read on a scale printed/scratched/etched on the wall of the cylinder.

For volumes of tenths of millilitres to millilitres, *graduated pipettes* are suitable. Suck up the liquid into the pipette (in the past, pipetting was commonly done by mouth, but today this is forbidden for safety reasons, so a balloon filler or a piston pump are used). **Only a clean and dry pipette may be inserted into the stock solution!** It is necessary to pipette slightly more than the required volume is. After removing the balloon/piston, close the upper end of the pipette with your forefinger and gently admit air – thus releasing the liquid – so that the meniscus of the liquid from above touches the line corresponding to the measured volume. Then bring the pipette vertically over the vessel and discharged the liquid by releasing the plugged opening.

In volumetric analysis you will also use undivided volumetric pipettes. Their internal volume is calibrated to the scratched line on the upper part of the pipette to which the meniscus of the liquid must reach. The pipetted volume is then slowly drained into an appropriate vessel (*e.g.*

titration flask). Do not blow out the pipette (the internal volume of the pipette is calibrated for a free spillage, *i.e.* it is corrected for the last drops remaining in the pipette tip; in addition, fatty substances from your breath could pollute the internal surface of the pipette and make it non-wettable). When the pipetted liquid has drained freely from the pipette, only touch the wall of the flask into which you have drained the pipetted solution with the pipette tip. This will empty the entire volume to which the pipette is calibrated. For repeated pipetting, do not clean the pipettes before each pipetting, but just rinse them repeatedly with a small amount of the new solution.

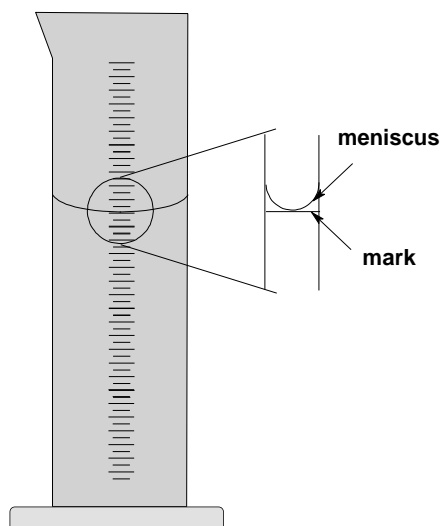

Fig. 21. Reading of the volume.

Droppers or *Pasteur pipettes* can be used for approximate measurements, *e.g.* for the number of drops.

Conveniently, *syringes* can be used to measure small volumes of solutions. These have a total volume of 1–50 ml and differ in steps of scale division. The most common types are plastic, but they can also be made of glass. They can be used successfully to measure volatile, toxic or odorous liquids.

For exact measurement of (even very small) volumes, piston pipettes (automatic pipettes) are commonly used (**Fig. 22**). Some of them have fix volume, but in other types it is also possible to adjust required volume in some range. Such adjustment is usually done by screwing of the push-button on the top of the pipette, and the current volume is shown on a display.

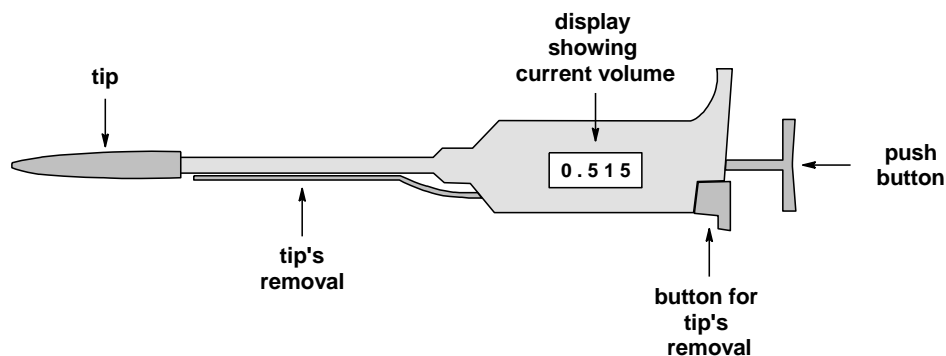

Fig. 22. Piston pipette.

Always put the tip on the bottom of the piston pipette when working with (it is forbidden use

the pipette without the tip). The tips are plastic and colour-coded according to their size (and therefore suitability for a given volume): usually white for 1.0–5.0 ml pipetting, blue for 200–1000 μ l and yellow for 20–200 μ l volumes. *The push-button has two positions – the set volume corresponds to the first position of the button, whereas the second position serves for complete removal of pipetted liquid from the tip.* To draw up the liquid, press the pipette plunger lightly to the first position and dip top of the tip below the level of the pipetted liquid. Then slowly release the plunger and observe whether the liquid is drawn into the tip. Always move the pipette with the drawn liquid in an upright position, *never lay it down.* When draining the liquid, press the plunger to the second position – this will squeeze the remains of the liquid out of the pipette.

When pipetting solutions in volatile organic solvents, spontaneous flow of the pipetted solution from the tip often occurs. This is because the evaporation of the solvent increases the vapour pressure inside the pipette body and pushes the solution out. This phenomenon can be reduced by drawing the solution into the tip and draining it several times before pipetting.

4.4 Measurement of temperature

Thermometers or electronic sensors (*resistance thermometers, thermocouples*) are most often used to measure temperature. Classical thermometers are based on the thermal expansion of a liquid enclosed in a bulb connected to a capillary. Mercury thermometers are the most common. When heated/cooled, the liquid (mercury) in the bulb changes its volume and then shows its temperature on a suitably calibrated capillary. When measuring the temperature of liquids (reaction mixtures, baths, *etc.*) using a thermometer, the entire bulb of the thermometer must be immersed in the measured liquid. At the same time it is necessary that the bulb of the thermometer does not touch the walls of the vessel (flask, bath, *etc.*). If the thermometer is broken, metallic mercury, whose vapours are very toxic, may leak. Therefore, any mercury drops must be disposed (see [Chapter 2.1](#)) and the accident must be reported immediately to the supervisor.

The resistance thermometers are made of materials whose electrical resistance changes significantly with temperature. The thermocouples use the change in voltage at the junction of two different metals as a function of temperature.

4.5 Measurement of pressure

To measure the atmospheric pressure in the laboratory (*i.e.* the atmospheric pressure, which fluctuates slightly around a value of about 100 kPa), a *barometer* is used, similar to the barometer used in meteorology. Various types of manometers are used to measure reduced pressure (*e.g.* when working with evacuated apparatuses) or even increased pressure (*e.g.* when working with high-pressure autoclaves). In practice, it is more common to work under reduced pressure.

In addition to modern (and expensive) electronic probes, a mercury manometer is still most commonly used to measure reduced pressure ([Fig. 23](#)). Its core is an U-curved thick-walled tube, closed on one side, filled with mercury. If you connect the manometer to the evacuated apparatus (by opening the valve), the mercury level drops down from the closed arm of the manometer, and its level rises in the arm connected to the apparatus. Theoretically, when a perfect vacuum is reached, the levels in both arms would be equalised. The difference in the height of the levels in the two arms indicates the value of the pressure in the apparatus; the unit is torr (1 mm of mercury column). To convert the pressure given in torrs to pascals the following relationship applies:

$$1 \text{ atm} = 101325 \text{ Pa} = 760 \text{ Torr (mmHg)}$$

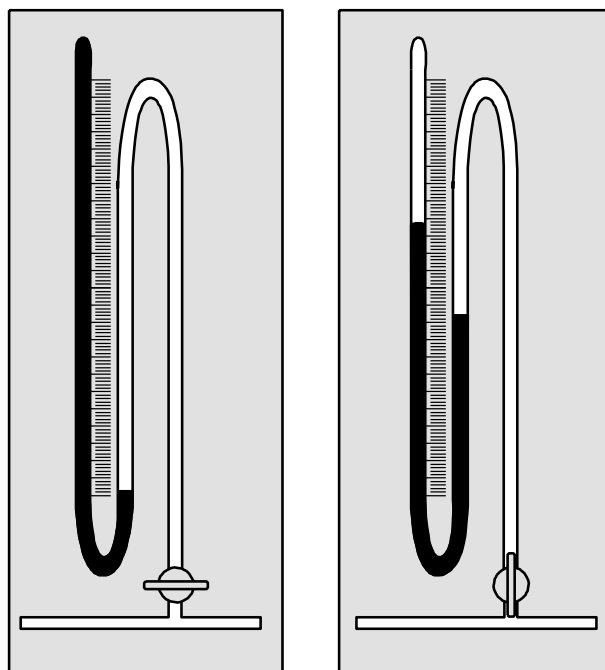

Fig. 23. Mercury manometer.

Sometimes (when careless handling occurs, *e.g.* tilting) an air bubble or even a small amount of liquid enters the closed arm. Such contamination will then expand when the manometer is connected to a vacuum source and the mercury level in the closed arm may drop below that in the open arm. Then, “negative” pressure can be read, which is obviously meaningless. Report such a malfunction to the supervising teacher.

Care should be taken when aerating the manometer. During this process the mercury will rise back to the end of the closed arm and can break it by its inertia, behaving like a hammer. Therefore, the air should be admitted slowly.

4.6 Determination of pH

In acid-base equilibria, a quantity called pH plays an important role. It is defined as the *negative decadic logarithm of the activity of oxonium ions*. The activity of an ion is directly proportional to its concentration, and the parameter of this proportionality is the *activity coefficient*. This is close to one for dilute solutions, so in practice its effect is neglected and the (relative) concentration is used in the above equation instead of the activity, *i.e.* $\text{pH} = -\log\{c(\text{H}_3\text{O}^+)\} = -\log[\text{H}_3\text{O}^+]$.

Because even pure water is partially dissociated into ions according to the equation:



the equilibrium constant of this autolytic process (when including the “constant” concentration of water in the water in the value of the constant) can be defined as:

$$K_w = [\text{H}_3\text{O}^+] \cdot [\text{OH}^-].$$

The constant K_w is called the *ionic product of water* and at laboratory temperature has a value of approximately $1 \cdot 10^{-14}$. Thus, its negative decadic logarithm $\text{p}K_w$ has a value of 14. In pure water, the concentrations of oxonium ions and hydroxide ions produced by autolysis are the same:

$$[\text{H}_3\text{O}^+] = [\text{OH}^-] = \sqrt{10^{-14}} = 10^{-7},$$

and the pH is therefore equal to 7. Solutions with this pH value are called neutral. If there is a higher concentration of oxonium ions than that of hydroxide ions in a solution, the solution is called *acidic* and the pH is *lower than 7*. In contrast, solutions with a higher concentration of

hydroxide ions than that of oxonium ions are called *basic* and their pH value is *greater than 7*. As an approximation, the pH can be determined using a *pH paper*. This is a paper impregnated with a mixture of different acid-base indicators which will colour differently in solution at different pH. The colour scale can then be used to estimate the pH of the solution with an accuracy of units (using a universal pH-paper) to tenths (using pH-papers specifically dedicated to the selected pH range).

For accurate measurement, a device called *pH meter* is used. This is a sensitive voltmeter that measures the change of *potential (voltage)* between the electrodes. The potential of one of them (the working electrode) depends on the concentration of oxonium ions (and therefore on the pH), whereas the potential of the other one (the reference electrode) is independent on the pH. Most often, the two electrodes are merged into a *combined* electrode (**Fig. 24**). The working (pH-sensitive) electrode is usually a *glass* electrode, the reference electrode is usually a *calomel* or *argent chloride* electrode. At the bottom of the combined glass electrode is a thin-walled glass bulb, which is very fragile. Therefore, the combined glass electrode must be handled very carefully. The electrode must be stored in an upright position – it must not be rotated bottom-up or even lied horizontally, as the internal electrolyte could leak out. The communication of the reference electrode with the measured solution is ensured by a small frit (bridge) located above the glass bulb. **During the measurement, it is necessary that this frit is immersed below the level of the measured solution** (**Fig. 24**).

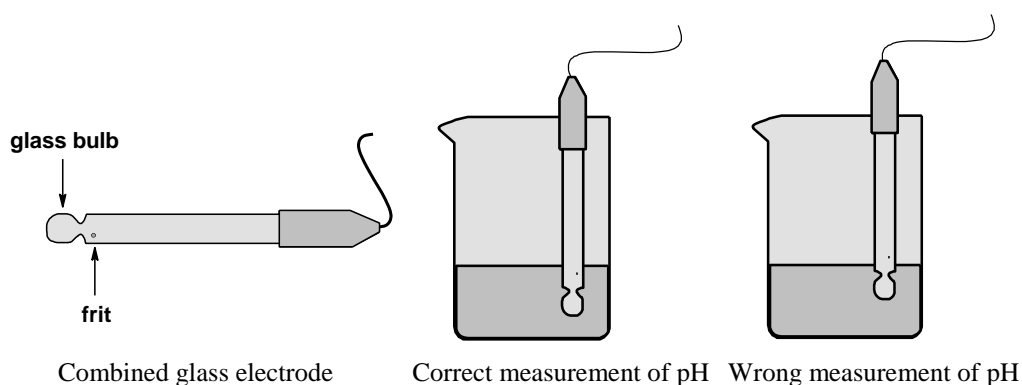

Fig. 24. Work with combined electrode

Since the pH meter reads the voltage (potential) values between the electrodes, it is necessary to perform a calibration – *i.e.*, to determine the conversion parameters of the measured signal from the voltage scale (typically in a unit of mV) to the pH scale. The combined electrode is immersed in a buffer of known pH value, and after equilibration, the desired value is set. Since the conversion of the mV scale to pH is linear, it is sufficient to calibrate the pH value at two points to determine the parameters of the calibration line – the linear term (slope) and the constant term (intercept, offset).

Calibration is most often performed on two buffers – one neutral, and the other with a pH value lying in the slightly acidic or slightly basic range, depending on the pH range of the planned experiment. The conversion of the measured voltage to pH is then usually set by the following procedure: first, the electrode is immersed in the neutral buffer (or a buffer with a value at least close to pH 7), and the old calibration line is moved to the desired height by setting the constant component (offset). The electrode is then placed in a second buffer (acidic or basic) and the slope of the calibration line is adjusted. The quality of the calibration is then verified by re-measuring the pH of the neutral buffer – if the calibration was done correctly, the measured pH does not differ from the original value. A graphical representation of the calibration process is shown in **Fig. 25**. Since in most pH meters the calibration line rotates around the neutral pH point, it is necessary to keep the order of the buffers and set parameters.

This statement can be easily proved graphically by drawing an analogy to [Fig. 25](#); the curious student can certainly handle it himself. Detailed instructions for the use of the pH meter can be found on the working place.

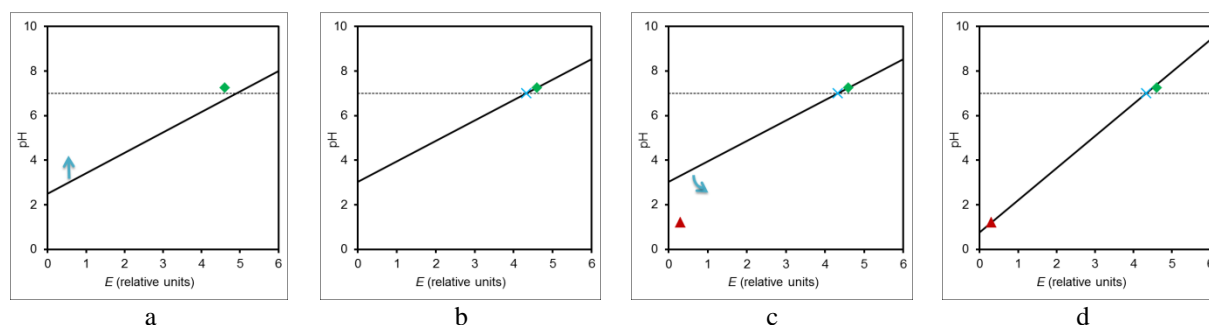

Fig. 25. Calibration of the pH meter: (a) previous calibration stored in the memory of the instrument with the first calibration point (green diamond); b) shifting the original calibration line to the first calibration point; the slope remains, the offset changes; c) measuring the second calibration point (red triangle) and adjustment of the slope so that the calibration passes through it – the instrument automatically sets the point of rotation of the slope (intersection of the new line and the neutral pH, pale blue cross); d) final calibration.

4.7 Heating

Various devices are used to heat reaction mixtures, such as *gas burners*, *heating nests*, *heating stirring plates* or *baths* heated on *heating plates* or over a burner. Annealing (heating to very high temperatures) can also be done using annealing furnaces, where well-defined temperatures of over 1000 °C can be achieved. Electric drying ovens can also be successfully used for heating to lower defined temperatures (up to about 200 °C).

To avoid a risk of *secret retardation* of reaction mixtures (*i.e.* superheating of the reaction mixture above the boiling point of the solvent used and its sudden rapid boiling), the heated mixture must be stirred. *Stirring bars* (small magnets coated with Teflon or sealed in glass) are used for this purpose. An alternative is the use of *boiling chips*. These are small porous pieces (most commonly shards of unglazed porcelain) which, when heated, release air bubbles from their pores, thus initiating the boil. Important note – if you stop heating of the water bath or reaction mixture, liquid will be drawn into the pores of the boiling chips and they are no longer working when reheated (no gas is present). Therefore, it is necessary to add fresh boiling chips each time the heating is restarted after the previous interruption. Do not store used cooking stones. *Throw them in the trash bin; do not pour them into the sink.*

4.7.1 Heating with gas burner and annealing

In orientation reactions or tube tests, a heating over a flame is very often used. In such cases hold the tube clamped in the holder at a slight angle and move it to mix the contents. The open end of the tube must be turned away from people, preferably into a corner of the room or a fume hood. Flammable organic solvents cannot be heated in this way. It should be remembered that only thin-walled tubes can be heated directly with a flame.

Direct flame heating of other glassware or parts of glass apparatus is carried out only in exceptional circumstances (*e.g.* when drying the apparatuses). In such cases, hold the burner in your hand and move it so that you only “lick” the heated glass with the flame, thus heating it as little as necessary and evenly on all sides. More commonly, suitable glassware – such as beakers and Erlenmeyer flasks – are heated on a wire grid, equipped with a ceramic fibre (formerly asbestos) target, placed on a tripod or on a ring mounted on a stand. *Never heat flasks with flammable solvents with an open flame.*

A special laboratory procedure is *annealing*. It is most often carried out in a porcelain crucible

over a flame, and is used to carry out reactions at high temperatures. At the beginning of the annealing process, the crucible must be heated gently to avoid its cracking by sudden thermal stress. Therefore, hold the burner in your hand and move it so that the tip of the flame heats the crucible only slightly. Once the crucible is heated, place the burner directly under the crucible so that the bottom of the crucible is in region of the maximum flame temperature (see [Chapter 3.3.3](#)). Alternatively, a furnace can be used for annealing – the advantage is that the temperature of the annealing can be well defined (controlled).

Annealing has applications also in analytical chemistry in *thermogravimetry*. In many cases, heating is accompanied by a defined decomposition and the stoichiometric coefficients of the relevant process can be calculated from the mass loss. To determine the mass loss on a small scale, it is necessary to work with maximum precision. This applies to the determination of the weight of the crucible used, the sample weight and the weight of the residue after annealing. Here, the *annealing to constant weight* is used: an empty crucible (or crucible with annealed product) is annealed in a triangle placed on a tripod or ring with the non-luminous flame of a gas burner for at least 5 min. A luminous flame must not be used – it reaches a lower temperature than a non-luminous flame and the soot deposits increase the weight of the crucible. Then remove the crucible from the triangle with chemical tongs and allow it to cool in the desiccator. *Do not touch the crucible with your hands*, as sweat can stick to it and potentially distort the result of weighing. Therefore, the crucible should be handled only with clean chemical tongs or tweezers. Then weigh the crucible on the analytical balances and repeat the annealing again for 5 min. Allow the crucible to cool and weigh it again. If the results of the weighing differ by more than ± 1 mg, repeat the annealing until the weight of the crucible obtained in the two subsequent weightings is the same (within 1 mg difference). **You have just performed annealing to a constant weight, so continue to work with the last weight determined. Do not average weights.** Although this is obvious, this error appears quite often in the protocols.

4.7.2 Heating on steam bath

Heating and evaporation on a water bath is most often done in a porcelain bowl heated from below by rising water steam. Often an improvised water bath, made from a beaker of adequate size ([Fig. 26](#)), is sufficient. Add boiling chips to the water bath to prevent superheating.

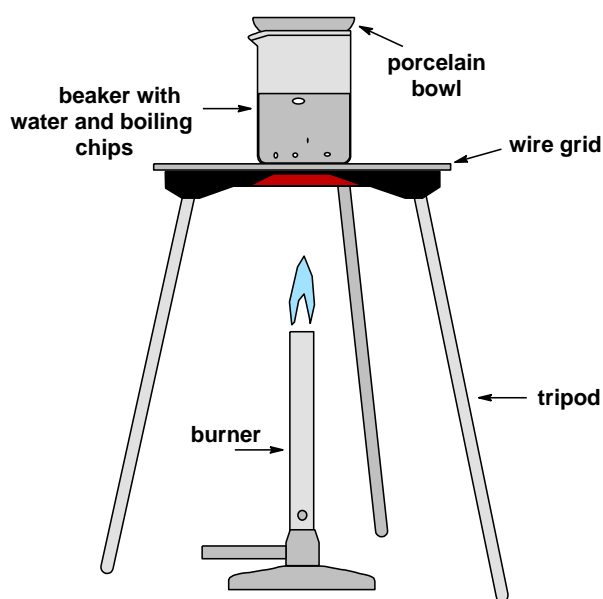

Fig. 26. Improvised steam bath.

4.7.3 Heating in bath

Prolonged *heating* of the reaction mixture to *boiling point* with simultaneous return of condensed solvent vapour back into the flask is called as *heating to reflux* (sometimes also *refluxing* in slang). Apparatus suitable for this purpose is shown in [Fig. 27](#). The reflux condenser prevents the vapour escape from the apparatus, and the condensate is returned to the boiling mixture. A stream of cooling water into the condenser should be set carefully to avoid pressurization of the hoses – this can potentially disconnect the supply hose from the condenser pipe and subsequently spray water around the laboratory. Even a very gentle continuous stream of water is sufficient to effectively cool the boiling mixture.

As the baths, metal pots filled with a suitable liquid are usually used. Iron pots should not be used when heating on the magnetic stirring plate as the material of the pot screen out the magnetic field, and therefore the stirring bar does not rotate inside the flasks. Aluminium or some stainless steel pots are suitable. Wide beakers can also be used. Depending on the bath filling, it can be used for heating to different temperatures; the most commonly used water (up to 100 °C) or oil (up to 180–220 °C, depending on the type of oil) baths are sufficient for most applications. For higher temperatures, sulphuric acid (up to 280 °C) can be used, or sand can also be used. *When heating beakers over a gas burner, it is necessary to use a wire net. Only water or sand baths can be heated over the burner.*

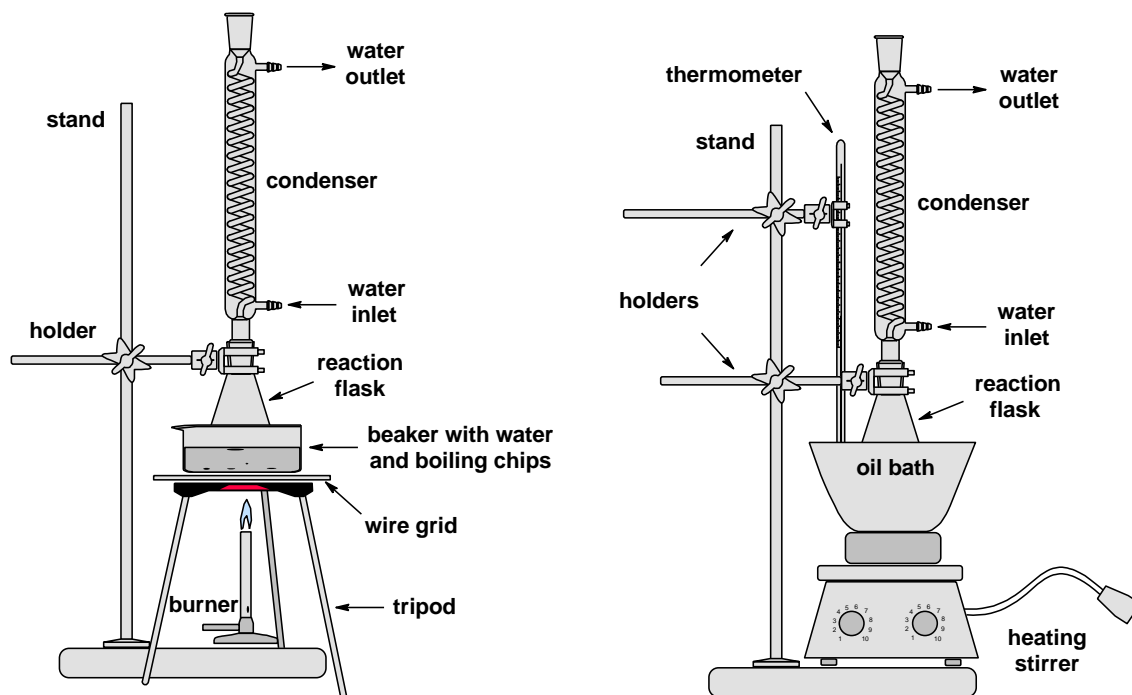

Fig. 27. Apparatus for heating to reflux.

Immerse the flask so that the level of the liquid in the bath is approximately same as the level of the mixture in the flask. The flask must not touch the bottom of the bath – it could crack due to point overheating. The level of the liquid in the bath must be sufficiently below the rim of the bath to prevent leak of the filling during handling.

Heat the bath to the desired temperature (measured with a thermometer or, in modern types of heating plates, with an electronic thermometer with feedback that allows precise temperature control in the bath) or, if the contents in the flask should boil, gradually increase the temperature to value at which the mixture in the flask will boil with a reasonable intensity. When using oil baths, it is very convenient to monitor the temperature of the bath by means of an inserted thermometer. If the bath is heated on a heating stirrer, set temperature on the

stirring plate about 20 °C higher than the desired bath temperature is. Similarly, to heat the reaction mixture to boiling point, the bath temperature must be higher by about 10–20 °C than the boiling temperature of the solvent.

If you are heating the reaction mixture to boiling (or to a temperature close to the boiling point of the solvent used) *you must not close the reaction apparatus* (with a stopper, etc.). Only reaction mixtures where there is no risk of gas/vapour evolution and which are stirred at laboratory or only slightly elevated temperatures can be closed with a stopper. In these cases, it is advisable to use a plastic stopper – it is very light and relatively soft and, if it is suddenly “shot” when the pressure inside the apparatus rises, there is almost no risk of material damage (breakage of the stopper or things in the vicinity).

When heating reaction mixtures containing oxygen-sensitive substances, it is necessary to use an *inert gas atmosphere* (N₂, Ar). Even in such cases do not close the apparatus with a stopper, but use e.g. a balloon filled with the inert gas (however, the technique of working in an inert atmosphere is beyond the scope of this course and is therefore not further discussed).

If the mixture to be heated is sensitive to the presence of air moisture, you can also use *drying tubes*. When filling them with desiccant, remember that air must pass freely through the tube – the desiccant must therefore be coarsely granulated. Do not press the desiccant in the tube, but just pour it freely and secure it with a plug of cotton wool to prevent spillage.

4.7.4 Heating in heating nest

Heating nests can only be used to heat round flasks. They are suitable for heating liquids to boiling. They cannot be used to heat to a defined temperature below the boiling point of the solvent. They can only be used for flasks of the appropriate size – nests are available for heating the flasks from 50 ml to 6 l. Heating nests are very suitable for rectifications (see [Chapter 4.14.2](#)) and for distillation of large volumes of solvents.

4.8 Cooling

Cooling baths are used to cool vessels in which exothermic reactions take place. The most common cooling medium is cold water or a mixture of water and ice. By mixing crushed ice with some salts, significant temperature drop can be achieved, e.g. a 1:3 mixture of sodium chloride with ice will reduce the temperature to –21 °C and a 1.4:1 mixture of calcium chloride hexahydrate with ice to –55 °C. However, these methods have the significant disadvantage of consuming a large amount of the salts. Very convenient cooling well below 0 °C is possible by a slow addition of crushed solid CO₂ (so-called “dry ice”) to ethanol or acetone. Theoretically, with the dry ice a temperature as low as –78 °C can be achieved. In all these refrigerating mixtures, care must be taken to ensure that the solid components are finely crushed, as the cooling efficiency depends strongly on the contact surface between the components. Also, for reaching of thermal equilibrium, a sufficient time is needed.

It is advisable to use a wide-opened *Dewar container* (*thermos*) as the vessel in which the low-temperature cooling bath is poured. This is most often a double-walled glass vessel with evacuated space between the thin glass walls (for good insulation properties of vacuum). Great care must therefore be taken when working with the thermos, as it can easily be damaged, which can be accompanied by a dangerous implosion.

Even lower temperatures can be achieved by cooling with liquid nitrogen (down to –196 °C). In this case the use of a thermos is an absolute necessity.

Of course, cooling efficiency is increased by stirring both the refrigerant and the refrigerated mixture.

4.9 Evaporation on vacuum rotary evaporator

When working with the evaporator (see [Chapter 3.5.6](#) for a description of the rotary vacuum evaporator), it is necessary to follow the correct procedure to prevent the evaporated mixture from bubbling and spitting. The solution flask is attached to the core tube with a clamp. The spinning is switched on and water cooling circuit is open. Then the diaphragm pump is switched on and the evaporator is evacuated by closing the aerating valve. It is necessary to wait until the mixture in the flask stops bubbling (at this stage it is sometimes necessary to slightly open the aerating valve to prevent the mixture to be evaporated from overflowing). When the liquid to be evaporated has stopped foaming and bubbling, the flask can be immersed in a heated water bath (the temperature of the bath depends on the nature of the evaporating solvent; for evaporation of low boiling organic solvents, 30–40 °C is usually sufficient, for evaporation of higher boiling solvents or water the bath must be heated to 60–70 °C). Note that the bath must not have too high temperature to avoid rapid boiling when the evacuated flask is immersed. The solvent is then allowed to evaporate, or the mixture is concentrated to the desired volume. After evaporation, the flask must first be removed from the bath, the evaporator aerated by opening the valve, the rotation stopped and the flask and product removed. Turn off the diaphragm pump at the very end of your work to allow any condensate or aggressive gases (NH_3 , HCl , *etc.*) to escape from the pump.

4.10 Crystallization

Crystallization is one of the most commonly used purifying operations in the chemical laboratory. If you dissolve a contaminated solid in a suitable solvent and then reduce its solubility (*e.g.* by changing the temperature, *etc.*), a substance with a higher purity than the original material crystallizes out and the impurities remain dissolved in the remaining solution (called *mother liquor*). Crystallization is most commonly carried out by the three methods described below, differing in the way by which the reduction in solubility is achieved. Of course, combinations of the methods described can also be used.

4.10.1 Crystallization by change of solvent (precipitation)

Let's assume a solution of some solid compound (*solute*) in a solvent. When another solvent which is miscible with the original one but which does not dissolve the given compound is added to the solution, the solubility of the solute is usually reduced in the resulting solvent mixture and the substance is precipitated as a solid phase. In inorganic chemistry, a mixture of water (in which most substances are soluble) and a suitable organic solvent (ethanol, acetone, tetrahydrofuran) is often used. The organic solvent is added to the aqueous solution with stirring. In the case of simple salts, the organic solvent can be added quickly, but in the case of more complicated products (which are, for example, various complex compounds, but also double salts or higher hydrates) it is recommended to add the precipitant to the first turbidity, and let the mixture to crystallize (or form crystallization seeds) at rest. Other portion of precipitating solvent as then added after a longer standing time. Adding too much precipitating solvent too quickly may cause that the product is expelled in oily form.

4.10.2 Crystallization by evaporation of solvent (reduction of volume)

Another option is crystallization by evaporation of part of the solvent (*thickening*). If the solvent is water, thickening can be carried out, for example, on an evaporation bowl heated on a water bath, but thickening of solutions in organic solvents must be carried out in special "closed" apparatuses, either by distillation (see [Chapter 4.14.1](#)) or (more conveniently) by thickening on a rotary vacuum evaporator (see [Chapters 3.5.6](#) and [4.9](#)). Concentration by the evaporator is a very simple and fast method, suitable of course also for aqueous solutions. As

can be seen from the principle of crystallisation, the purified substance must always remain in contact with the mother liquor – evaporation to dryness lacks the purifying effect and may also lead to product decomposition (*e.g.* loss of crystal water).

4.10.3 Crystallization by change of temperature

The solubility of most substances in different solvents changes with temperature. It usually increases (sometimes very significantly), although in rare cases a solubility may decrease with increasing temperature. Examples of this anomalous behaviour are *e.g.* calcium hydroxide, calcium acetate, calcium chromate, lithium carbonate, lithium sulphate or zinc phosphate.

The usual temperature dependence of solubility is employed in a technique of crystallization by lowering the temperature of a hot saturated solution. Erlenmeyer flasks without a condenser may be used to heat aqueous solutions; however, to reduce evaporation, it is advisable to insert a small funnel into the neck of the flask when heating. Beakers can also be used; the beaker should be covered with a watch glass when heating.

However, when crystallising from organic solvents, you must use the flask equipped with a reflux condenser (it avoids evaporation of the solvent into the laboratory atmosphere). Add a small amount of the solvent through the condenser to the substance placed in the flask (with the stirring bar or at least boiling chips) and heat the mixture while stirring. When working with flammable solvents, use only electric heating stirrers/hotplates; water can also be heated with a gas burner. If the liquid starts to boil and the solid is not completely dissolved after stirring, add another portion of the solvent. Prepare a nearly saturated solution (slightly diluted) at boiling point by addition of the solvent in small batches with continuous heating. After filtration (usually through a folded filter paper or through a plug of cotton wool, see [Chapter 4.12.1](#)), the hot filtrate can be either allowed to cool slowly at rest (so-called *free crystallisation*), or the filtrate can be rapidly cooled by immersing the flask with the filtrate into a cooling bath or under a stream of cold water in a sink with stirring the contents of the flask by a circular movement (so-called *disturbed crystallisation*). In the former case, the compound will form large crystals; these may, however, contain cavities in which the mother liquor with impurities is enclosed. In the latter case, rapid cooling of the stirred solution will result in the crystallization of the small crystals, which have better purity but have a large surface area on which the mother liquor with impurities can be adsorbed. It is therefore necessary to wash them carefully. Sometimes, the material formed by disturbed crystallization is too fine and difficult to filter.

4.11 Trituration

The *trituration* technique is used in isolations of many chemical compounds. This is a process in which a future solid (most often initially of a chewy or oily appearance) is stirred with a solvent in which it is insoluble (and any impurities optimally are). In practice, a small amount of solvent is added to evaporated material in the flask and the content of the flask is scraped and powdered with a glass stick or spatula. After removing the first portion of the mother liquor (by dropper or careful *decantation*, see [Chapter 4.12.2](#)), a new portion of solvent is added and the process is repeated until the product is converted to a powder.

4.12 Filtration and vacuum-filtration

4.12.1 Filtration

Separation of the undesirable solid phase from the solution is carried out depending on the grain size of the solid. Large grains can be removed by simple filtration through a cotton wool plug. The main advantage of this procedure is that it is very fast, which does not allow the

filtrate in the funnel to cool too much, which could lead to crystallization of the solute (as often happens during filtration through a filter paper). It is therefore suitable for filtering *e.g.* hot saturated solutions. A small piece of cotton wool (just big enough not to fall through the funnel stem, **Fig. 28**) is placed in a small funnel and the filtered solution is poured through it into a new vessel (beaker, reaction flask, separating funnel, *etc.*).

Fine precipitates, or activated carbon, *etc.*, must be filtered through a *filter paper*. Cut a square of filter paper of suitable size from the sheet and fold it into quarters. Cut out the corner using scissors to form a circle of the filter paper. Pull one layer of the folded paper away from the others to form a cone and place it (after moistening) into the funnel (**Fig. 28**). The moistening is done for adhesion of the filter paper to the funnel walls – the filtration will be then accelerated by the capillary forces between the paper surface and the funnel glass. Obviously, ribbed funnels cannot be used for this type of filtration. When filtering a solution for analytical purposes (without further dilution to a defined volume), it should be remembered that any moistening of the paper would dilute the filtered solution. In these cases, of course, do not wet the filter paper. Similarly, do not wet the paper before filtering organic non-water-miscible phases. In such cases filter through a folded filter paper. The advantage of a folded filter is that the whole surface of the filter paper is used for filtration (contrary to the round filter folded into quarters). Filtration is therefore faster and it is also suitable for working with hot saturated solutions. The folded filter is prepared as follows: fold the cut filter paper round in half and fold it into an accordion (**Fig. 28**).

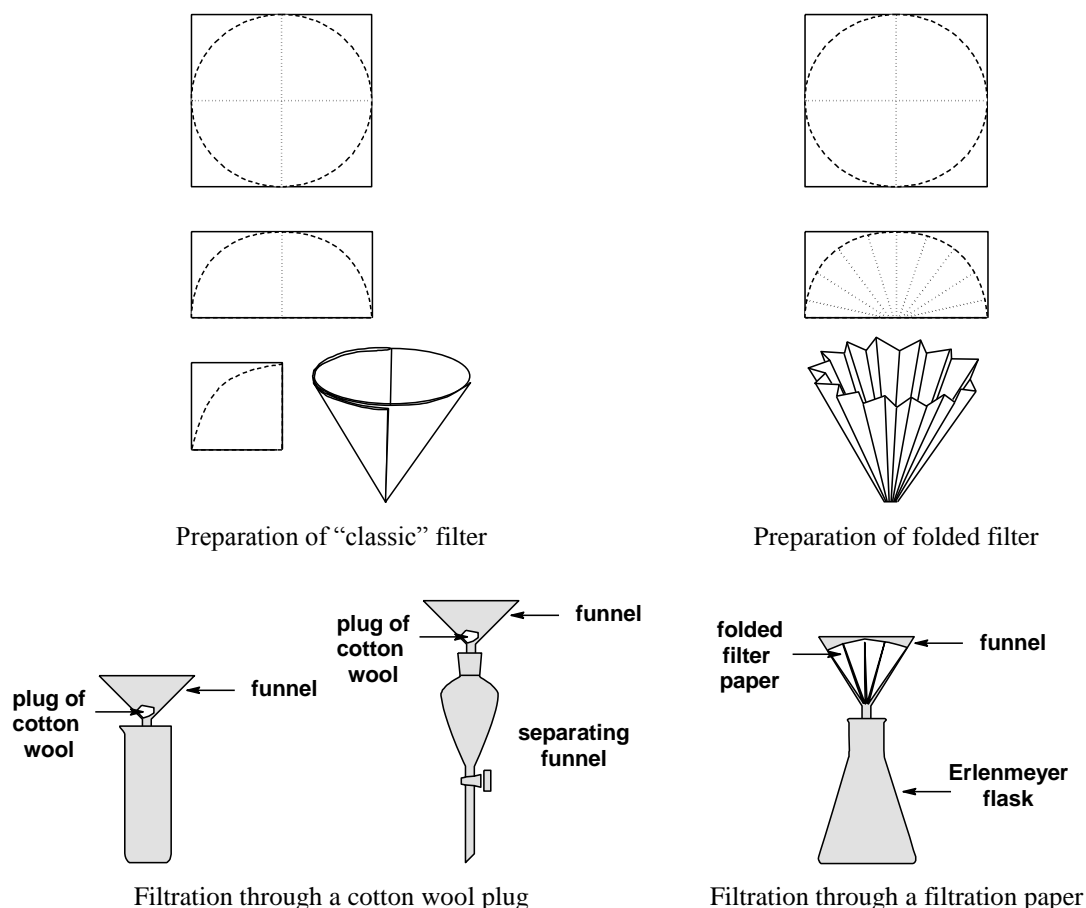

Fig. 28. Filtration.

Insert the stem of the funnel into the collecting vessel (so that the stem of the funnel touches the wall of the vessel and the filtrate runs down the wall without spitting droplets) and carefully pour the filtered solution onto the filter paper. In order not to “splash” the filtered

liquid when pouring, pour it onto the filter paper using a glass stick. Place the stick against the spout of the beaker with the filtered suspension, and hold the bottom of the stick over the filter paper. Never touch the filter paper with the stick – wet filter paper is not mechanically resistant and can be damaged easily.

4.12.2 Vacuum-filtration on Büchner or Hirsch funnel and on frit

If the solid product from the liquid phase is separated, we usually use *vacuum filtration through filter paper on a Büchner or Hirsch funnel* or *vacuum filtration on a frit*. This is how most of solid products are isolated in chemical synthesis.

When working with a Büchner/Hirsch funnel, place a circle of filter paper on the bottom of the funnel so that it covers all holes and is in contact with the bottom of the funnel with its whole surface. It must not be bent upwards along the wall of the funnel, as this would make channels between the paper and the wall. The air can pass through such channels which reduces efficiency of the filtration. In extreme case, also the filtered suspension may flow through it. It is therefore necessary to cut out a circle of filter paper of the exact size ([Fig. 29](#)). The mother liquor is typically collected into the filter flask. *The rubber sealing must be inserted between the Büchner funnel and the filter flask!*

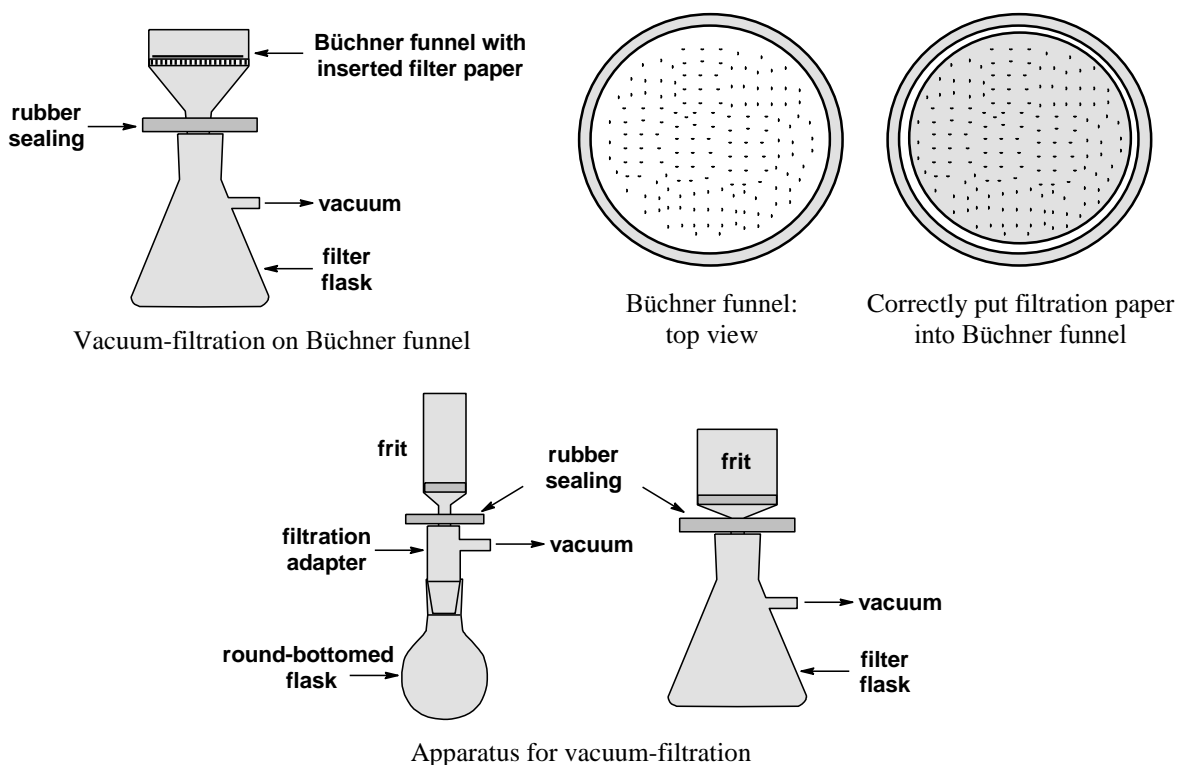

[Fig. 29](#). Vacuum-filtration.

Filtration under reduced pressure on the frit is based on a similar principle. This is used both to isolate solid products and to remove mechanical impurities from the solution. Accordingly, a filter flask is used to collect the filtrate, if the solid phase is isolated, or a round-bottomed flask, if the filtrate is of importance (the filtrate can be conveniently further processed in such flask, *e.g.* evaporated). After assembly of the apparatus ([Fig. 29](#)), a filtered suspension is poured onto the frit and the apparatus is connected to a vacuum pump. This procedure is called *sharp vacuum filtration* and leads to a compact filter cake. After removal of all mother liquor from the cake, the vacuum source is disconnected, the washing solvent is poured over the cake and the material is properly stirred with a stick or spatula. This can be done here

(unlike when working with a Büchner funnel) because the frit is mechanically resistant compared to filter paper. The vacuum is then applied again. The procedure can be repeated if necessary. During the last processing, the filter cake can be pressed with the top of the glass stopper – this will squeeze out any residual liquid phase and speed up the drying of the product.

When filtering fine precipitates, it is often advantageous to let the product suspension settle and first pour clear mother liquor onto the frit or Büchner funnel. After this clear solution has been passed through the frit/funnel (with a minimum of solid product remaining on the frit/paper), remaining suspension is filtered. If the suspension is filtered from the beginning, the frit (or filter paper) is immediately clogged and the filtration is time consuming; at least the first (clear) portion is filtered relatively quickly using the above procedure. The process of pouring the clear solution over the precipitate is known as *decantation*.

The filtered product can be easily scraped out of the frit (due to the mechanical resistance of the frit) with a glass stick or a spatula. However, this method cannot be used to isolate the product from the Büchner/Hirsch funnel, where the product would be contaminated by fibres of filter paper. In these cases, therefore, very carefully catch the edge of the filter paper with tweezers and smoothly pull the filter paper out of the funnel onto the watch glass or Petri dish with product side down. Dry the filter paper by pieces of filter paper or cotton (with slight pressing) and then peel off. The product will remain glued to the watch glass (Petri dish) and can be dried in the drying oven.

4.13 Separation of non-miscible liquids and extraction

The *separation* of two *immiscible liquids* of different densities can be done using of a separating funnel. The separating funnel with the poured mixture is allowed to stand for a few minutes (*e.g.* in a filter ring attached to a stand, [Fig. 30](#)) until the layers are gravitationally separated according to their density. When the separating funnel is left to rest, some vessel should be placed under it, so if the valve will not work properly and some solution leaks, it will not contaminate the working place. The bottom layer is then carefully drained off with opening the valve so that the liquid interface is just trapped in the core of the valve. The upper phase is then poured out through the neck to avoid contamination by the lower phase trapped in the valve and a pipe tube below.

The immiscibility of liquids can be employed in a process known as *extraction*. Extraction is the transfer of a substance (product) from a solid or liquid mixture into a suitable solvent. The simplest extraction technique is *shaking*. It is most commonly carried out in a mixture of water and a suitable organic solvent immiscible with water. The compound dissolved initially in one phase passes into the other phase until equilibrated distribution between the phases is established. During transfer of the dissolved component from one solvent phase to the other, intensive shaking is necessary to mix the immiscible phases in order to increase their interfacial surface and make the extraction faster. Therefore, the separating funnel should be closed with a stopper and the contents should be well shaken. However, because heat is sometimes released during extraction and the organic solvents are often volatile, the pressure inside the separating funnel often increases. Therefore, when shaking, it is necessary to hold the separating funnel neck down with one hand on the neck (and hold the stopper to prevent it from falling out) and to hold the valve with the other hand. Then, time-to-time (especially early after mixing) it is necessary to open the valve and allow to equilibrate the pressure inside with the atmospheric pressure.

It is better to shake several times with a small amount of the solvent than once with a large amount, as the efficiency of repeated shaking is much higher than that of a single shake with the same total volume of the solvent.

Some practical advices: the phase separation after mixing can be speed up by gentle circular

movement of the separating funnel. This also removes the droplets of the heavier phase that are stuck to the walls. Addition of an indifferent salt (NaCl, KCl, *etc.*) usually helps to separation of the phases. When the salt is added, it dissolves in the aqueous phase. This slightly increases its density and usually makes the aqueous phase more separable from the lighter organic phase; moreover, dissolution of the ionic salt in the aqueous phase usually reduces the solubility of non-polar organic molecules and the tendency of the organic phase to form emulsions. This approach can be particularly useful in the extraction of the lighter organic phase with water. Sometimes the two liquid phases are so intensively coloured and dark that their interface cannot be distinguished. It can be solved by use of an infralamp – in its light the phase interface is usually revealed. A common mistake made by students is to try to drain the liquid from a closed separating funnel – after the first few millilitres the liquid flow stops. The resulting lowered pressure inside the funnel then makes it hard to open.

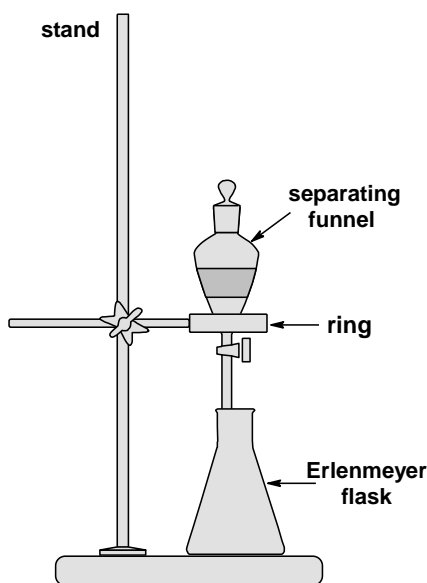

Fig. 30. Apparatus for extraction or separation of liquid phases.

The isolated organic phase needs often to be “dried” (*i.e.* water remains should be removed, *e.g.* before distillation or evaporation). This can be done by addition of a suitable desiccant (usually anhydrous sodium or magnesium sulphate) to the “wet” organic phase (usually cloudy) and standing the liquid in contact with it until the desiccant reacts with all the water to form a hydrate and the liquid phase clears. Drying should be carried out in closed flask to prevent the absorption of air moisture into the dried organic phase. Erlenmeyer flasks are very suitable for this purpose. Add the drying agent in small portions and stir the flask by a circular movement. Initially, the grains of the drying agent fall quickly to the bottom forming lumps and/or sticking to the walls. When there is sufficient amount of desiccant, its particles rise when stirred. A few minutes of standing, with occasional swirling of the desiccant, is usually sufficient to dry the organic phase. Then filter off the drying agent through folded filter paper or frit. Do not wet the filter paper!

4.14 Distillation

An important purification technique of volatile liquids is distillation. The principle of distillation is to heat the liquid into steam, conduct the steam and condense it. When a of volatile liquid is heated, the partial pressure of the compound above the liquid phase gradually increases until it equilibrates with the ambient pressure (usually atmospheric) – the liquid begins to boil. The boiling point is therefore obviously dependent on the external pressure. It

can be seen in the *phase diagram*. The typical shape of phase diagram is shown in [Fig. 31](#). The curves on the phase diagram indicate under what conditions (*i.e.* pressure and temperature) the two phases of given compound are in equilibrium; thus, on the diagram, these curves separate the existence regions of each phase. Point **O** is called the *triple point*. It is the point that indicates at what temperature and pressure all three phases of the given compound will be in equilibrium. The *boiling point* (*i.e.* the temperature at which the vapour pressure above the liquid phase is equal to the external pressure) is represented by the line between the sectors corresponding to the liquid phase (denoted by **l**) and the gas phase (**g**). At higher external pressure, the boiling point of the liquid is higher – on this principle, for example, pressure cookers work. Conversely, when the external pressure is reduced, boiling occurs at a lower temperature. This happens, for example, in high-altitude regions – it is a well-known fact that mountaineers do not boil hard-boiled eggs in boiling water (the boiling point of water at an altitude of about 5000 m is about 80 °C). This is exploited by *reduced pressure distillation* (so-called by the Latin *in vacuo*), where the application of a vacuum can lower the boiling point of the distilled liquid by up to several tens of degrees.

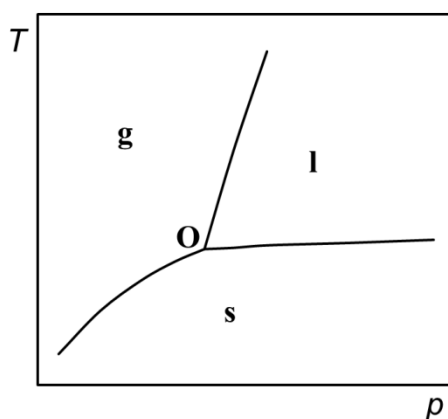

[Fig. 31](#). Scheme of state diagram: **O**: triple point, s: solid phase, l: liquid phase, g: gas phase.

4.14.1 Simple distillation at normal or reduced pressure

Simple distillation means heating the liquid to a boil, conducting its vapour into a descending condenser and draining the condensate into another vessel (collecting flask). This method can be used to separate a single liquid substance from a mixture with non-volatile (solid) substances (*e.g.* distillation of water from a solution of salts), or from a mixture of liquid substances whose boiling points differ significantly and which do not form an azeotrope (see [Chapter 4.14.2](#) 4.14.2 for a definition of an azeotrope).

Distillation can be carried out either at atmospheric or reduced pressure. The advantage of working at reduced pressure is apparent from the definition of boiling point and from [Fig. 31](#), where the boundary between the **g** and **l** fields shows the dependence of boiling point on pressure. A reduction in pressure leads to a reduction in boiling point, and thus compounds which would decompose at normal boiling point can be distilled under reduced pressure.

At present, the most common apparatuses are made up from components equipped by ground joints ([Fig. 32](#)). The apparatus consists of a distillation flask in which the liquid boils, a distillation adapter, a descending (straight Liebig) condenser, a receiving adapter with side tube, and a flask for collecting the distillate. It is also quite common to use a special condenser that integrates the distillation adapter (so-called Claisen condenser) or both the distillation and receiving adapters. The use of a collecting splitter is advantageous, as it allows changing the collection flasks very conveniently without the need to disconnect the apparatus.

This is particularly useful when distillation is performed under reduced pressure. In the case of separation of a mixture of liquids, the efficiency of separation can be considerably increased by the use of a distillation column (see [Chapter 4.14.2](#)).

The flask in which the liquid is boiled is fixed (*via* its neck) vertically using a holder on the stand. The descending condenser should be fixed in approximately halfway along its length by a holder on a second stand. However, the condenser must not be fixed too tightly, as the stress of the glass during heating/cooling could cause a breakage. Therefore, the jaws of the holder serve more as a support in which the condenser is placed. The collecting flask should be only supported from the bottom, *e.g.* with a rubber or cork pad. Do not fix it to the holder (the stress on the glass would be very high). Preferably, a thick catalogue of chemicals (which you open at the appropriate thickness) can be used to support the flask.

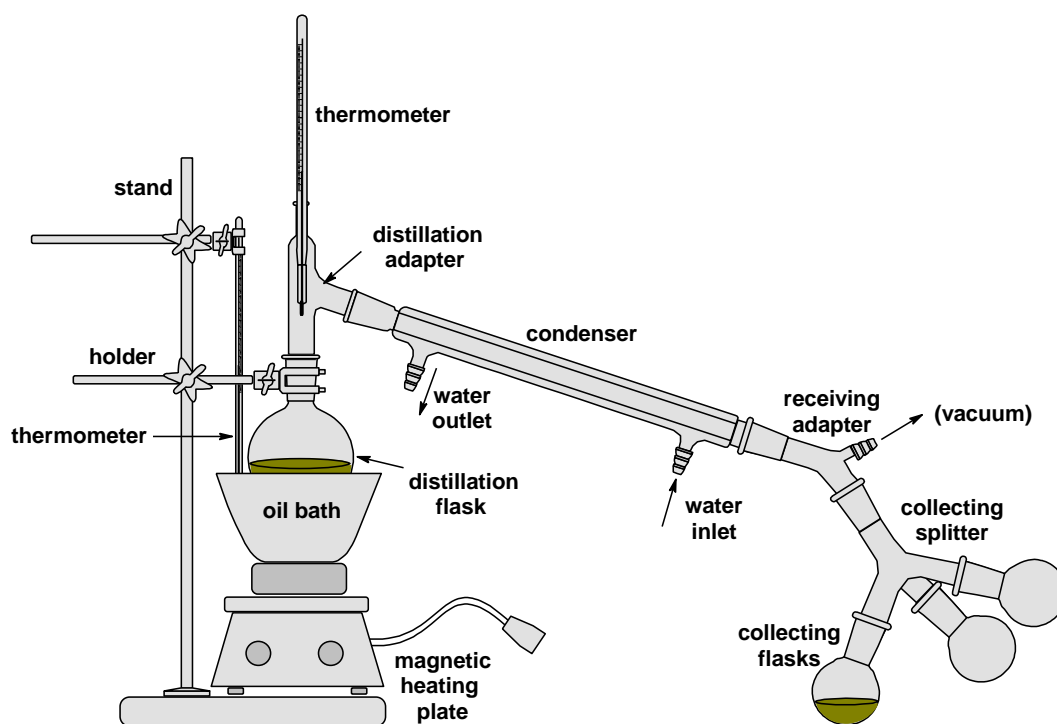

Fig. 32. Apparatus for distillation at normal or reduced pressure.

The direct tube of the distillation adapter must of course be closed during distillation, either with a stopper (if you are only thickening the mixture in the distillation flask and do not need to know the vapour temperature of the distilled liquid) or with an thermometer (this is necessary to check the boiling point if you want to distil a pure substance). The stem of the thermometer must be long enough so that the mercury flask is at the vapour inlet to the condenser.

The tube of the receiving adapter is used to connect the apparatus to the vacuum pump when distilling under reduced pressure (never directly, always *via* a safety bottle or at least a tube with a valve). But even at normal pressure distillation, the tube plays an important role – thanks to it, the space inside the apparatus communicates with external (laboratory) atmosphere, and the pressure is equalized (heating a completely sealed apparatus would lead to pressure increase and explosion). In cases where it is necessary to prevent the entry of air moisture into the distilled liquid (*e.g.* when distilling dried solvents), the tube of the adapter serves to connect with a drying tube.

The flask in which the liquid is heated to boil must not be more than two-thirds full. When distilling at atmospheric pressure, the heated liquid must contain boiling stones or the contents

of the flask must be stirred on a magnetic heating plate. When distillation under reduced pressure is performed, the use of magnetic stirrers is a necessity. There is no other way to prevent a superheating, as the boiling stones do not work (from obvious reasons) in the evacuated apparatus. In the past, regular boiling during reduced pressure distillation was ensured by supplying air/inert gas below the level of the distilled substance by a thin capillary, but this practice has been abandoned.

When heating in the bath, it is usually advisable to immerse the flask as deeply as possible so that the vapours of the distillate will not condense on the cooler walls of the flask above the level of the bath but in the condenser.

If the distillation is performed using a heating nest, the liquid must not be distilled off completely – there is a danger of spot overheating and cracking of the flask. In the case of heating in an oil bath, this danger is eliminated. However, the nature of the distilled liquid and of distillation residue must also be taken into account – if, for example, an anhydrous solvent is distilled from a mixture of solvent and drying chemical (*e.g.* Na, CaH₂, *etc.*), it must never be distilled to dryness, but some solvent must remain in the distillation flask and safely cover the drying agent used. There is a particular danger in distillation of ethers, in which organic peroxides may be present which are very explosive when dried and heated.

When distillation is carried out under reduced pressure, it is necessary to measure the pressure inside the apparatus with an attached manometer. It is also necessary to check the laboratory glassware used very carefully for cracks. *Because of the risk of implosion, a protective shield must be always used when working with evacuated apparatus.*

4.14.2 Rectification

An usual dependence of the boiling point and composition of the gas phase on the composition of the liquid phase consisting of a mixture of two miscible liquids A and B is shown in the diagram in [Fig. 33a](#). The shape of these dependencies follows from physical chemistry and its derivation is beyond the scope of this course. The upper curve in the figure shows the equilibrium composition of the vapour, the lower curve shows the composition of the liquid phase. The fact that these curves are not identical allows separation of the liquid components of a homogeneous mixture by distillation (for obvious reasons, only those mixtures in which the vapour composition at boiling temperature differs from that of the boiling liquid can be separated).

The above discussed dependence of the composition of the gas and liquid phases is the most common, but not the only possible one. An alternative is the formation of an azeotrope, where, for a given composition of the mixture A+B, the compositions of the gas and the liquid phases are identical. Such a mixture has a boiling point either higher than the boiling points of both pure components (azeotrope with maximal boiling point, negative azeotrope) or lower than the boiling points of both pure components (azeotrope with minimal boiling point, positive azeotrope). This fact is reflected in the phase diagram by touching the curves determining the composition of the liquid and gas phases above (or below) the boiling point of the individual components. The shapes of the diagrams for the two-component systems A+B are shown in [Fig. 33b,c](#).

Let's go back to the most common case shown in [Fig. 33a](#). The lower boiling compound A (the more volatile component) has a higher concentration in the vapour than in the liquid, and the concentration of the higher boiling compound B has lower concentration in the vapour than in the liquid. If the initial liquid mixture contains a % of the more volatile (lower boiling) component A, the mixture will boil at temperature $T_B(a)$ and the resulting steam and condensate will have a higher content of component A, namely a' %. If this condensate is heated to boiling, it will boil at temperature $T_B(a')$, and the vapour and other condensate will again have a higher content of component A, namely a'' %. The distillate of the third

distillation at boiling point $T_B(a'')$ is then even richer in component A and contains a''' % of it. It can be seen that with an infinite number of such repetitions we would get a distillate containing pure component A.

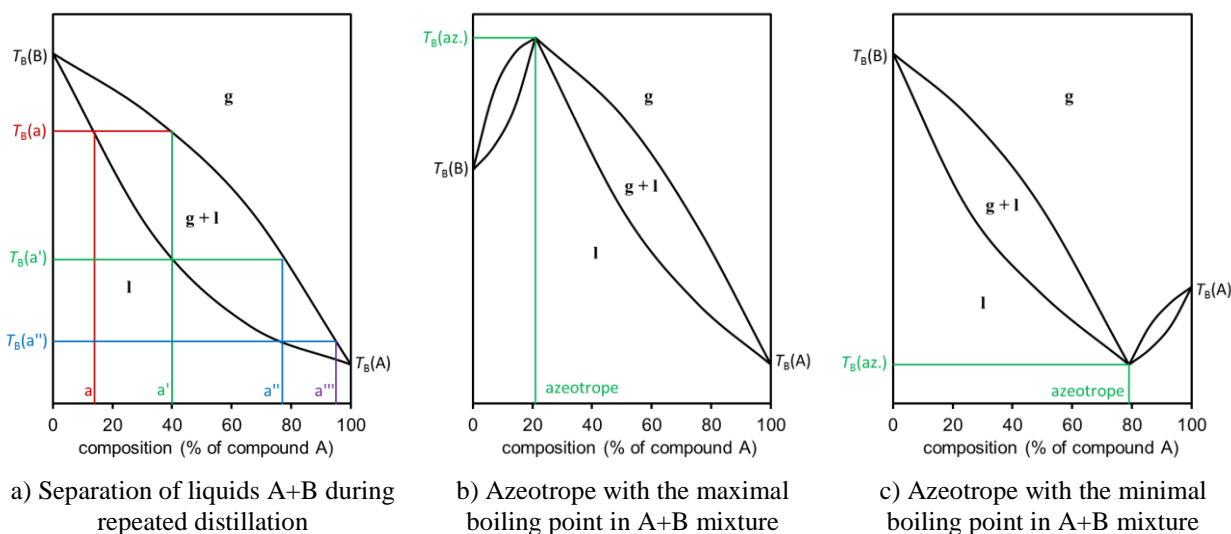

Fig. 33. Rectification: l: liquid phase, g: gas phase.

In practice, *rectification* (sometimes referred to as *fractional distillation*) is used to approximate the condition described above, see **Fig. 34**.

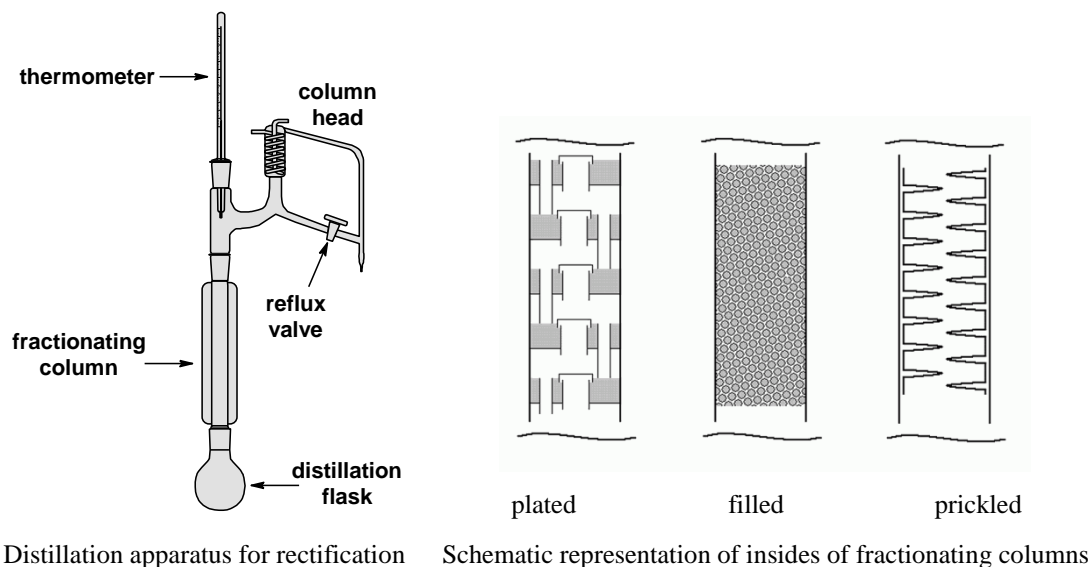

Fig. 34. Rectification.

In this process, the different “distillation stages” are in equilibrium, which is established in a device called a *fractionating column*. This is a thermally insulated tube in which several plates are connected by tubes, in one of which the steam rises upwards and in the other the condensate flows downwards. The rising steam heats the condensate in the higher plate and evaporates the more volatile component which moves further up. Conversely, the liquid phase condensed in the lower plates is enriched with a higher boiling point component. Above the column, there is a *column head*. It consists of a condenser in which complete condensation of the vapour takes place. A valve is connected to the condenser, which allows a certain part of the condensate to be drained off into a collecting flask and the rest to be returned to the

column. This valve is referred to as the *reflux valve* and the relative amount of liquid phase returned is referred to as the *reflux ratio*.

In addition to the fractionating column described above, tubes with a large internal surface are more commonly used as columns in practice. The simplest cases are the columns with various fillings, *e.g.* glass beads, porcelain beads, *etc.*, or the columns whose inner surface is enlarged by glass prickles. For a schematic representation of the different types of columns, see [Fig. 34](#).

4.14.3 Steam distillation

According to *Dalton law* (the derivation of which is the subject of physical chemistry and outside the scope of this course), the equilibrium vapour pressure over a mixture of two immiscible liquids is equal to the sum of the equilibrium vapour pressures over the isolated phases. As a consequence, the boiling point of the mixture (*i.e.* the temperature at which the vapour pressure equals the external pressure) is lower than the boiling point of the pure lower-boiling component. The amounts of substance of the components in the vapour are in proportion to their partial pressures. This phenomenon is utilized in *steam distillation*, which is mostly used to purify organic substances with a high boiling point under normal pressure (up to 300 °C) that are not miscible with water. This operation is carried out by passing water steam through a tube to the bottom of a distillation flask containing a mixture of the crude substance and water. The steam is generated in separate multi-necked flask or flask equipped with a side tube. A safety tube (a straight tube at least 80 cm long) passes through one neck of the flask, the lower end of which is just above the bottom, and a short tube is passed through the other neck to carry the steam to the flask containing the distilled crude material. The steam line from the steam generator must be as short as possible to limit heat loss and water condensation. The steam generated by boiling water heats and stirs the contents of the distillation flask and carries the steam of the distilled substance to the condenser. The boiling chips or stirring bar must be placed in the steam generator but not in the distillation flask. To avoid too much water in the distillation flask (condensation of the steam brought in), the contents must be adequately heated. The distillate is collected until it is heterogeneous (*i.e.* it contains two liquid phases). This can be easily determined by taking a sample of the distillate in a small test tube. A typical apparatus for steam distillation is shown in [Fig. 35](#).

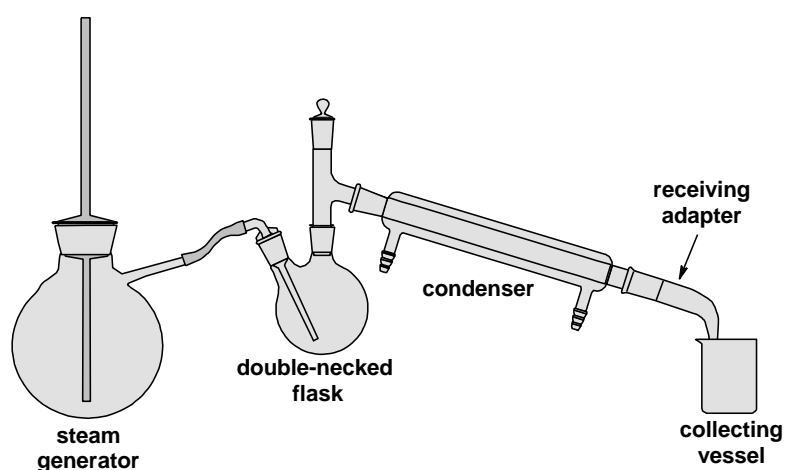

[Fig. 35](#). Apparatus for steam distillation.

4.15 Sublimation

Sublimation is the direct transition of a compound from a solid to a gas phase. It occurs when

the vapour tension over a solid reaches an external pressure at a temperature lower than the melting point of given compound. This temperature is then called the sublimation point, T_s . Most solids can theoretically sublime under suitable conditions. These conditions can be seen from the state diagram of given compound. A typical phase diagram is shown in [Fig. 31](#) (see [Chapter 4.14](#) for a description). The curve separating the solid (s) and gas (g) phase existence fields and the triple point position **O** are important for sublimation. For most substances, the triple point occurs at pressures lower than atmospheric pressure. It means that under normal laboratory conditions such substances cannot sublime. For some substances (*e.g.*, iodine, ammonium chloride, salicylic acid, naphthalene, *etc.*) the triple point, and thus the part of the curve showing the equilibrium between the gaseous and solid phases, is shifted to a region of higher pressure and temperature. Thus, the sublimation point of such substances can be reached by heating at normal (atmospheric) pressure. So, the sublimation can be advantageously used to purify such substances.

It can also be seen from [Fig. 31](#) that by lowering the pressure a reduction in the sublimation temperature can be achieved. Therefore, it is also convenient to purify some substances by sublimation under vacuum.

The simplest apparatus for sublimation of small quantities of substances under normal pressure can be constructed from two watch glasses. The sublimated substance is placed on the lower glass. The glass is then covered with a perforated filter paper (which will prevent the sublimate from falling back) and concavely covered with a second watch glass on which the sublimated product will be deposited. The lower glass is then gently heated, and the upper glass can be cooled, *e.g.* with filter paper strips moistened with cold water. Sublimation of larger quantities can be easily performed using a beaker into which a flask of ice water is inserted, as shown in [Fig. 36](#).

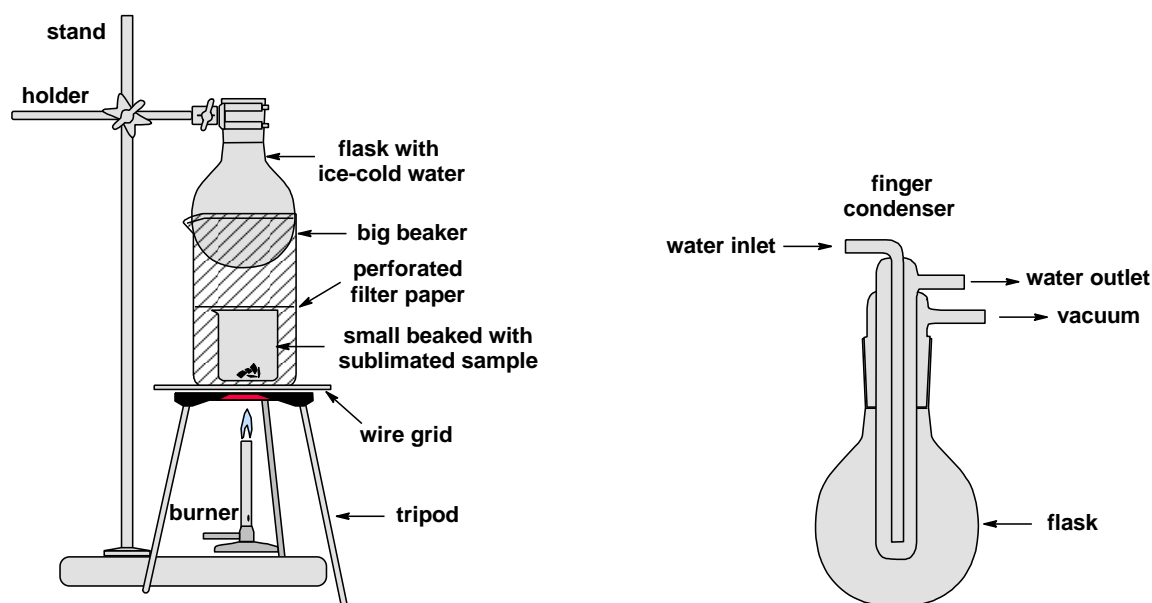

Fig. 36. Apparatuses for sublimation. Left: simple sublimation with product collection from outer surface of a cold flask. Right: sublimation with active water cooling and possibility to use a vacuum.

The special sublimation apparatus consists of a round-bottomed, wide-throated sublimation flask into which a water condenser (*cold finger*) is placed, see [Fig. 36](#). The contact of the cold finger with the flask is made by ground joint with a side tube, allowing the possible application of a vacuum, but the connection may also be sealed by a rubber or cork plug. The apparatus should be heated only slightly. The vapours of the sublimated substance are cooled on the surface of the condenser, from which the solid sublimate is gradually removed.

4.16 Chromatography

In synthetic practice, mixtures of products are often separated by various chromatographic methods. Chromatography is also used to check the purity of the prepared or isolated compounds. Chromatographic methods are based on the partitioning of the components of a mixture between a stationary (immobile) and a mobile phase.

4.16.1 Column chromatography

The most common chromatography is performed employing an adsorption on the *stationary phase* (*sorbent*; most commonly silica gel or alumina, but microcrystalline cellulose is also used) placed in a column. The sample is deposited on the column top and washed with a *mobile phase* (*eluent*; this is a suitable solvent or solvent mixture). If there is a mixture of compounds and these have different affinities for the sorbent in the column and for the mobile phase, the individual components travel through the column with different rates and separate from each other. [Fig. 37](#) shows a schematic representation of the chromatographic process – the initial mixture of two substances A (triangles) and B (crosses) is poured onto the column with the sorbent. Further washing of the column with the mobile phase separates them – substance A has a lower affinity for the stationary phase than substance B, so it flows through the column faster, while the travelling of substance B through the column is retarded. After a period of washing, the two substances travel separately in separate zones.

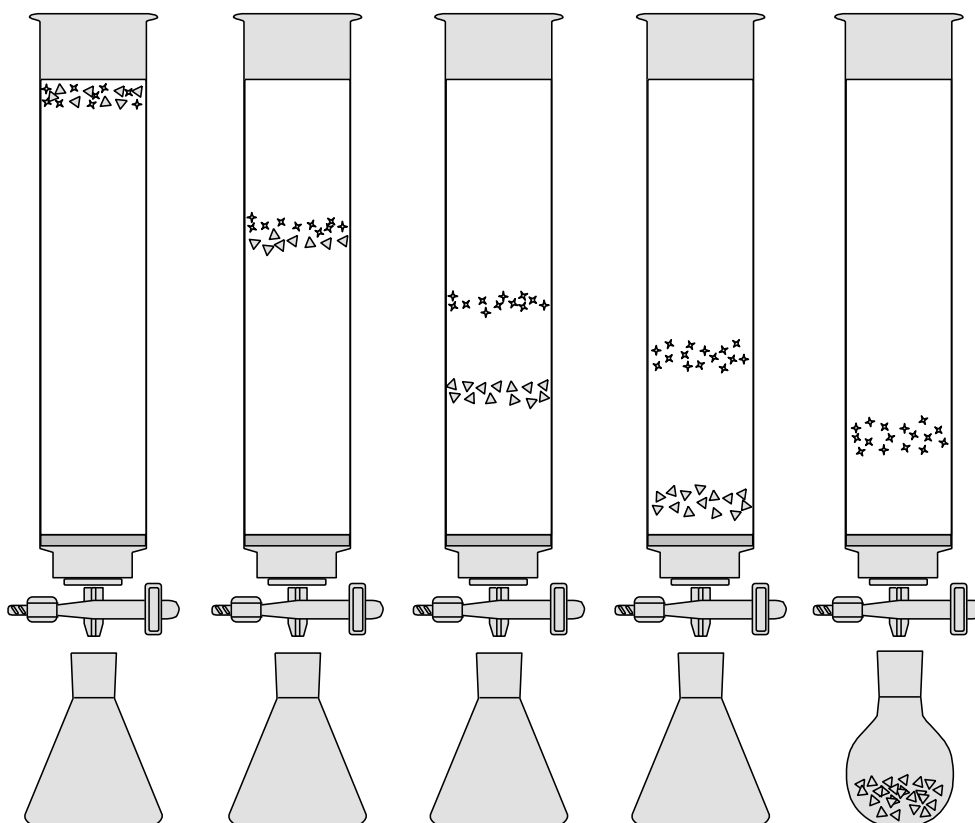

[Fig. 37](#). Schematic depicting of chromatographic separation.

4.16.2 Thin-layer chromatography

The instrumentally simpler version of chromatography is *thin-layer chromatography* (TLC). A layer of the stationary phase (sorbent) is adhered (with dextran, gypsum, etc.) to a solid non-absorbing support, for example, aluminium sheet (most common), a plastic foil, or a glass plate. Silica gel is most commonly used as the sorbent, other sorbents (alumina,

microcrystalline cellulose) are less common.

Chromatography plates are cut from a large commercial plate with scissors as rectangles with a length in the direction of eluent flow of approximately 6–10 cm, and their width is chosen according to the number of applied samples. The sample is applied as a small droplet to the start at the bottom of the plate. It is advisable to mark the start with a pencil at a distance of about 10 mm from the bottom edge of the plate; the pencil should also be used to mark the points to which the samples are applied. A suitable distance between these points or from the side edge of the plate is about 7–10 mm.

It is advisable to apply the samples as a solution in a volatile solvent so that the applied droplet dries quickly. Glass capillaries or plastic tips can be used for application. Plastic tips have the advantage over capillaries that they do not have sharp edges and therefore there is lower risk of damage of the thin sorbent layer when applying sample droplets. The solution should be drawn into the capillary by simply dipping the end of the capillary below the surface. Touch carefully the capillary with the sample solution to the sorbent layer at the appropriate mark. Make sure that the diameter of the spot formed by the solution on the chromatographic layer is no more than 5 mm. If the applied solution is not concentrated enough, the application may be repeated. However, it is necessary to wait until the solvent from the previous batch evaporates before a new application.

Place the plate vertically in the *developing chamber (cell)* with a layer of mobile phase ≈ 5 mm high. The mobile phase layer must be below the “start”, otherwise the sample will be extracted into the mobile phase layer. The developing cell can be improvised *e.g.* with a beaker covered with a Petri dish. Before development, the solvent from the sample droplets must be completely evaporated from the plate. When developing the chromatogram, it is important to cover the cell to prevent evaporation of the eluent from the thin layer and to avoid change of composition of the mobile phase. The eluent flows upwards due to capillary forces and carries and separates the compounds from the sample. After the mobile phase rises almost to the end of the plate, remove the plate from the cell. A top boundary of the mobile phase is called *solvent front*. Mark it directly on the plate with a pencil (as well as the start and sample application sites), see [Fig. 38](#). Allow the mobile phase to evaporate (evaporation can be accelerated by gentle heating, for example over a heat gun).

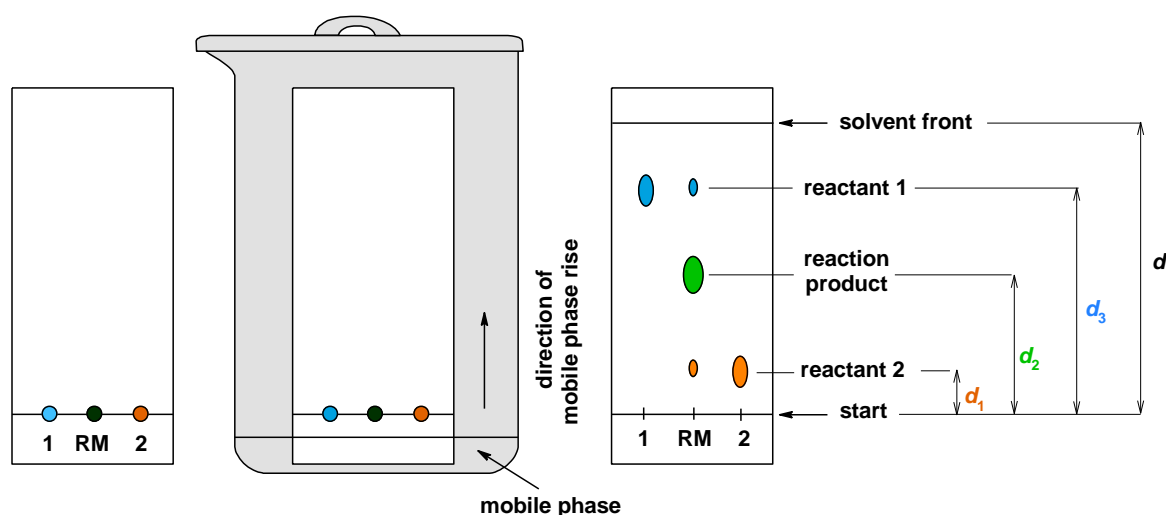

The TLC check of model reaction mixture (RM): $\text{reactant 1} + \text{reactant 2} \longrightarrow \text{product}$

[Fig. 38](#). Performance of thin-layer chromatography.

During the course of chromatography, the individual components present in the sample separates according to their affinity for the sorbent surface and the mobile phase – *i.e.* they

reach different heights on the final TLC plate. The relative spot-to-start distance compared to the front-to-start distance is characteristic for a given compound (in a given system and on a given sorbent) and is called the *retention factor*, R_F , sometimes also called the *retardation factor*. Thus, for compounds travelling with the front, the retention factor has a value of 1, while substances remaining at the start have R_F value of 0. Thus, for the example given in [Fig. 38](#), $R_f(\text{reactant 1}) = d_3/d$, $R_f(\text{reactant 2}) = d_1/d$ and $R_f(\text{product}) = d_2/d$.

When you separate the compounds that absorb the visible light, they show up as coloured spots on the plate. However, most compounds are not coloured, so you need to make their spot *visible (detectable)* on the plate. Various techniques and tricks are used to do this, depending on the chemical nature of the separated substance. Chromatography of substances that absorb in the ultraviolet region is preferably carried out on thin layers containing some fluorescent indicator (called a phosphor, *i.e.* a substance that absorbs UV radiation and emits the received energy in the form of visible light) that is not washed out by the eluent. When the chromatogram is irradiated with a UV lamp, the UV-absorbing substance present disrupts fluorescence of the phosphor and will appear as a dark spot, which you can outline with a pencil. Substances that show their own fluorescence can be detected as luminous spots on plates without phosphors. The most commonly used chemical detection reagent is iodine, which makes most organic substances visible. Place the plate in a container with some small amount of iodine for a few tens of seconds. The iodine vapour adsorbs on the surface of the organic matter, producing visible spots. The general detection reagent for most organic compounds is sulfuric acid. The plate is sprayed with a solution of H_2SO_4 which, when heated, blackens the areas where the separated substances are present. However, for obvious reasons, this detection cannot be used on plates with an organic sorbent (cellulose) or glued with an organic binder (dextran). If the detected substances contain amino groups, solution of ninhydrin can be used for detection.

The number of spots presents on the chromatogram formed from a single sample may correspond to the number of compounds contained in the sample, but may also be less, as some compounds need not separate chromatographically under chosen conditions. If the spots are poorly visible (indistinct) the chromatography must be repeated with a higher concentration of the sample. Conversely, too high concentration of a sample causes an elongated spot (tail) and poor resolution of individual spots.

4.16.3 Chromatography on ion-exchanger

Ion exchange resins can be used to separate ionic substances. These are copolymers of an inert monomer (*e.g.* styrene) with monomer units bearing a polar substituent (acidic, *e.g.* $-\text{CO}_2\text{H}$, $-\text{SO}_3\text{H}$; or basic, *e.g.* $-\text{pyridyl}$, $-\text{NR}_2$, $-\text{NR}_3^+$). The resulting polymer resin is then used most commonly as fillings in columns. The polymer with acidic substituents then binds cations from the poured solution (this is a cation exchanger, called *catex* in laboratory slang), while the polymer bearing basic groups binds anions (this is an anion exchanger, *anex*). According to the acidity/basicity of the polar groups used, strong ($-\text{SO}_3\text{H}$) and weak ($-\text{CO}_2\text{H}$) catexes can be distinguished as well as strong ($-\text{NR}_3^+$) and weak ($-\text{pyridyl}$, $-\text{NR}_2$) anexes. The function of the ion exchanger is illustrated schematically with the example of the sodium chloride solution poured on a strong catex. When the NaCl solution is poured onto the column, the strong sulfonic acid bound to the resin is neutralized, releasing hydrochloric acid, which is eluted (washed out) with water from the column ([Fig. 39](#)).

Regeneration of ion exchangers is carried out by pouring a large excess of strong acid (most often diluted hydrochloric acid) and washing out the eluate to neutrality with water. The cationic ion exchangers are thus converted into the H^+ -cycle (they are in their acidic form), the anionic ion exchangers are converted into the Cl^- -cycle, in which they are also usually stored (they can be converted into the free base form – *i.e.* the OH^- -cycle – by pouring a

alkaline hydroxide solution through them, but in this form the anexes degrade on prolonged standing).

During prolonged storage of the ion-exchanger, the liquid level in the column cannot drop below the level of the ion exchanger – *the grains of the exchanger must not be exposed to air for long periods of time*, as drying would cause cracking of the swollen polymer and destruction of the individual grains.

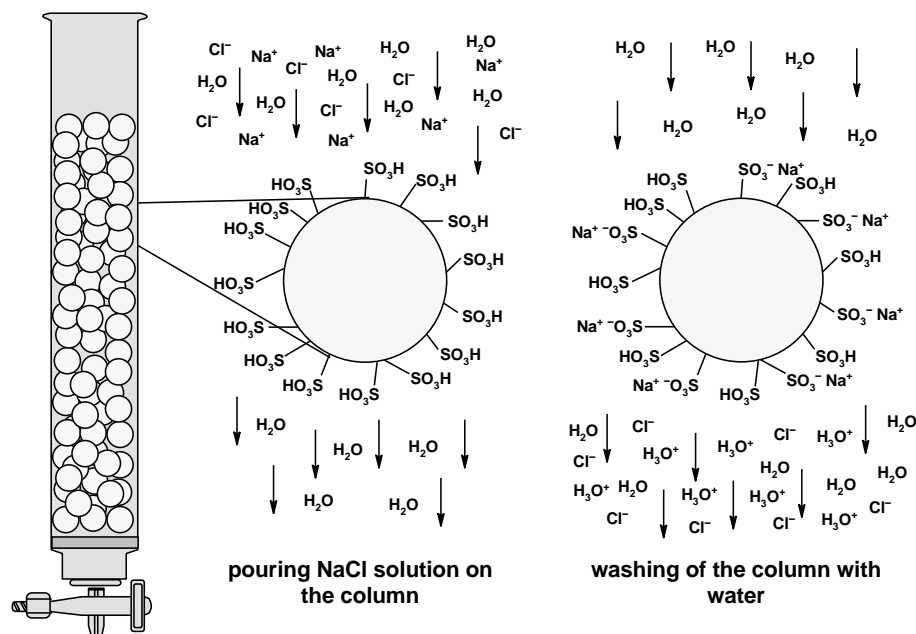

Fig. 39. Schematic depicting of separation of ions in solution of NaCl using strong cation exchange resin.

4.17 Determination of density

In practice, special vessels of precisely defined volume – *pycnometers* – are used to measure the density of a liquid (**Fig. 40**).

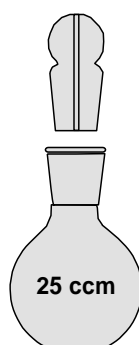

Fig. 40. Pycnometer.

These are filled with the liquid, after closing with a stopper with a capillary hole the excess liquid is displaced through the hole and wiped off. Thus the volume of the sealed liquid is very precisely defined. The pycnometer with the liquid is then weighed and the weight of the empty pycnometer is subtracted to obtain the weight of the sealed liquid. By weighing a liquid of known density (usually water), the exact volume of the pycnometer can then be calculated:

$$V = \frac{m_{\text{water}}}{\rho_{\text{water}}}$$

and then the density of the studied liquid can be calculated:

$$\rho_{\text{sample}} = \frac{m_{\text{sample}}}{V}$$

The typical unit in which density is given is $\text{g}\cdot\text{cm}^{-3}$.

Pycnometers can also be used to determine the density of solids. By weighing the pycnometer with the solid, the mass of the solid sample can easily be determined, and from the differences between the masses of the pycnometer filled with suitably chosen liquid, the pycnometer with the solid sample filled with the liquid and the pycnometer with the solid sample, the volume of the solid phase can be calculated (with knowledge of density of the used liquid). This technique is beyond the scope of this course. However, the perceptive reader can readily derive the appropriate calculation procedure.

4.18 Determination of melting point

The melting point is defined as the temperature at which the solid and liquid phases of a given substance are in equilibrium. In [Fig. 31](#) (see [Chapter 4.14](#)), the dependence of melting temperatures on pressure is shown by a curve separating regions of the solid (s) and liquid (l) phases. It can be seen that dependence of the melting temperature on pressure is tiny, unlike the boiling or sublimation temperature.

The melting point measured at laboratory pressure is an important physical constant for different compounds. Particularly for organic compounds, comparison of the measured melting point with the tabulated value serves for a quick identification of *e.g.* reaction products. The melting point value is also very sensitive to the purity of the compounds. The presence of some impurities usually significantly lowers the melting point compared to the pure compound (tabulated value).

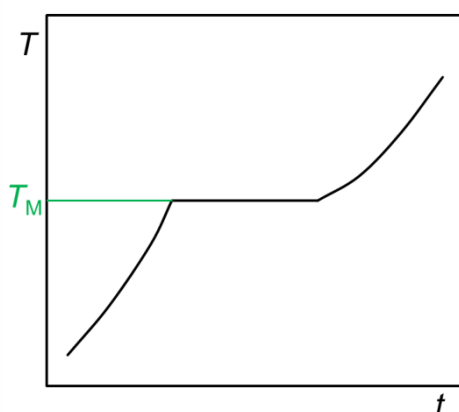

Fig. 41. Dependence of sample temperature (T) on time (t) during heating. T_M represents melting temperature.

[Fig. 41](#) shows schematically the time dependence of the temperature of a sample when it is heated. Initially, the temperature increases steadily until the melting temperature T_M is reached. At this temperature, the energy supplied is consumed for the phase transition and the temperature remains constant as long as some solid phase is still present in the sample. After all the solid phase is converted to the liquid phase, the temperature begins to rise again as pure liquid phase is heated.

By measuring the time dependence of the sample temperature we could determine the melting temperature very accurately, and related procedures are used in the study of phase diagrams of more complex systems. However, these methods have a number of technical drawbacks and require large amounts of the samples. Therefore, a different procedure is used for routine determination of the melting point. A small amount of the sample is packed (compacted) in a

glass thin-walled capillary, which is placed in a melting point apparatus. Then the temperature on the display of the apparatus and the capillary with the sample are observed simultaneously (see [Chapter 3.5.7](#)). The melting temperature is the temperature at which the liquid phase appears, or the range of temperatures between which the sample completely melts (*i.e.* from formation of the first liquid to full homogeneous melting).

4.19 Determination of refractive index

An important and characteristic property of liquids (and optical media in general) is the refractive index, n . It is defined as the ratio of the speed of light in vacuum ($c = 299792458 \text{ m}\cdot\text{s}^{-1}$) to the speed of light in a given liquid/material (v), *i.e.*:

$$n = \frac{c}{v}.$$

As the speed of light depends on the wavelength of light and the temperature of the environment, these parameters are expressed as subscripts/superscripts. For example, the notation ${}^{20}n_D$ means the value of the refractive index at laboratory temperature (20 °C), measured at a wavelength of 589.3 nm, which is the average value of the wavelengths of the spectral lines of the doublet D of sodium lamp, $\lambda = 589.0$ and 589.6 nm, respectively (the most commonly used wavelength for refractive index measurements). It is obvious that the refractive index value for a given material is always greater than one (the speed of light in vacuum is the maximum achievable speed). The refractive index of air is very close to one (1.00029) at laboratory temperature and normal pressure, for common transparent substances it is somewhat greater than one (water 1.333, common window glass 1.479), but for some substances it goes up to values of about 2.5 or more (lead glass about 2, diamond 2.42, synthetic rutile 2.61).

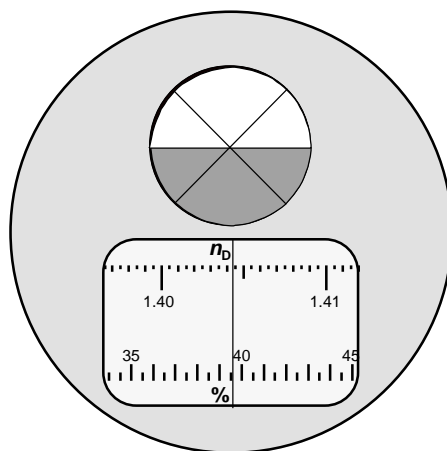

Fig. 42. Field of view of refractometer; $n_D = 1.4044$.

A device called a *refractometer* is used to measure the refractive index. In this practicum, you will use an Abbe refractometer (see [Chapter 3.5.8](#)). When measuring the refractive index, apply a sample onto a perfectly cleaned (and dried) illuminating prism (use such an amount of the sample that when the illuminating prism is covered with the measuring prism, the layer of measured liquid is spread over entire contact area of the prisms; usually a few drops are sufficient). After covering the illuminating prism with the measuring prism and switching on the light, look into the eyepiece. By adjusting (rotating) the optical system of the instrument, the limiting beam of the total internal reflection of light on the thin layer of the sample is measured. If the angle of this limiting beam is Θ , then the following relation applies:

$$n = n_{\text{air}} \cdot \sin \Theta.$$

Achieving of total reflection is indicated in the field of view by the relative position of the thread cross and the light/shadow interface shown in [Fig. 42](#). The scale of the device is, for practical reasons, calibrated not in values of the angle θ , but directly in refractive index scale, n (upper scale in the Figure). Usually the device is equipped with another scale, which is used for some of the most common industrial applications, *e.g.* for determination of the sugar content of sugar solutions (lower scale in the Figure).

4.20 Work with gas cylinders (bombs)

Most of gases needed in the laboratory are available highly pressurized or liquefied in storage gas cylinders. These cylinders are colour-coded so that you can quickly see what gas they contain. However, it is important also to check the label on the cylinder to see if the cylinder contains the required gas.

Most often, gas cylinders with compressed nitrogen or argon are used. These gases are used to provide an inert atmosphere when working with easily oxidizable compounds. Other common gases supplied in cylinders are compressed air, oxygen, hydrogen, carbon dioxide, acetylene, carbon monoxide, ammonia and chlorine.

Different types of valves (pressure-reducing regulators, [Fig. 43](#)), usually equipped with a manometer (gauge) or flow meter, are used for the controlled flow of gas from the cylinder. Working with these varies somewhat from type to type. There is always a *main valve* on the top (valve which releases the gas from the cylinder into the high-pressure chamber of the pressure-reducing regulator; this part is often equipped with a manometer), and a *pressure-reducing valve* which opens the path from the high-pressure to a low-pressure chamber and to an outlet pipe. A second manometer or flow-meter is usually placed behind the reducing valve. The drain pipe is usually equipped with another auxiliary valve. While the main and auxiliary valves are conventional (similar to a tap), the pressure-reducing valve ([Fig. 43](#)) has a specific design that allows the pressure to be continuously regulated from high values (inside the cylinder) to low values (a flow to the apparatus). The special feature of the pressure-reducing tap is that it closes by loosening and opens by tightening, *i.e.* virtually it works completely opposite to the other two valves. By tightening the pressure-reducing valve, the rubber plug is pushed out and the gas flows from the inlet channel into the low pressure chamber of the regulator and then out through the outlet pipe. Conversely, as the gas pressure rises in the low pressure chamber, the diaphragm is pushed against the control screw and the rubber plug seats against the inlet channel, stopping the gas flow.

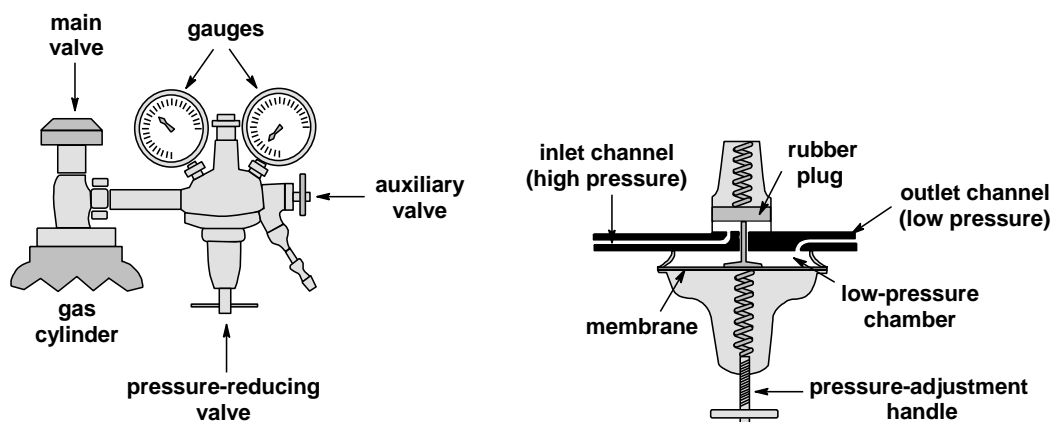

[Fig. 43](#). Pressure-reducing regulator equipped with two manometers (gauges) mounted on a gas cylinder and schematic representation of pressure-reducing valve.

In general, the following rules should be followed when working with the gas cylinder: make

sure that the pressure-reducing valve (and the auxiliary valve if present on the given type of regulator) is closed before start of your work. If this was not the case, and you will open the main valve, uncontrolled pressurization of the apparatus could occur and the apparatus could “explode”. Open the main valve. It is enough to open it slightly; there is a large excess of gas inside the cylinder, which will quickly refill the loss of gas in the high pressure chamber. If both pressure-reducing valve and the auxiliary valve are present, it does not matter in which order they are opened. Here it just depends on which one has finer regulation – usually it is the pressure-reducing valve. In such case, open the auxiliary valve slightly, and set the desired flow by slow tightening (opening) of the pressure-reducing valve. Check the gas flow visually during the procedure, *i.e.* follow a bubble counter attached to the apparatus.

4.21 Work with melted glass

The input material is usually a glass pipe. It is advisable to use thin-walled pipes (they melt faster). They must be cut to a suitable length. This can be done with a file or a special knife – a scratch is made in the long pipe at a suitable distance from the edge. The pipe can then be easily broken at this point (see [Fig. 44](#)). It is advisable to hold the pipe over a cloth to reduce a chance of possible cuts from sharp edges.

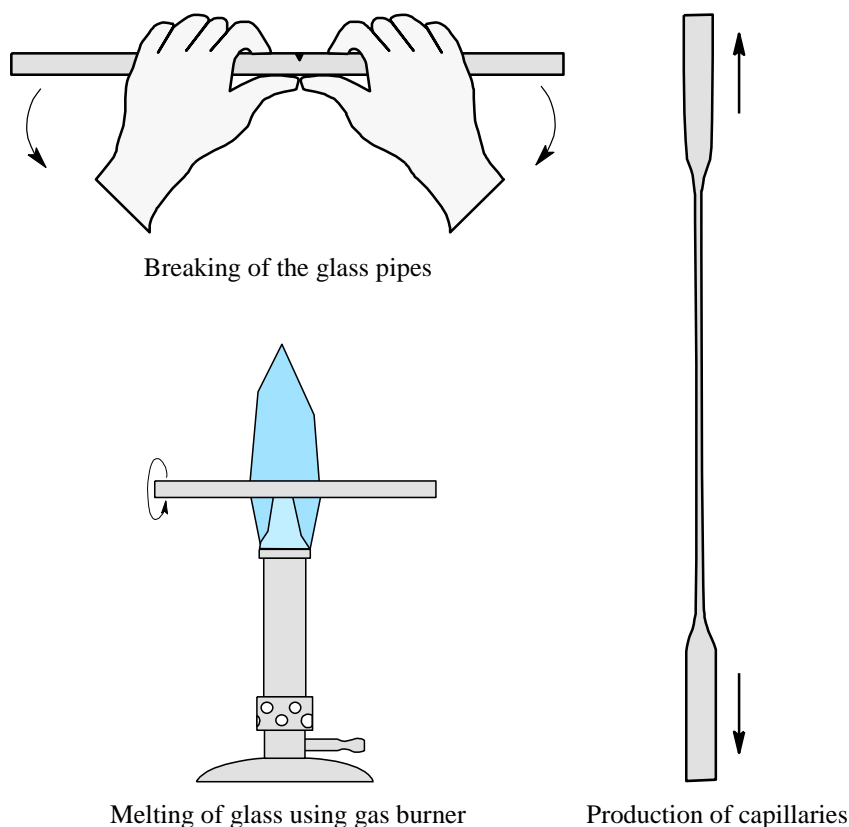

Fig. 44. Work with glass.

The broken sharp ends need to be *rounded* by a slight melting – the pipe end is placed in the flame of the gas burner and turned until the edges are melted and rounded. The glass must be slightly pre-heated in close proximity to the flame before being placed directly into the flame (usually in the hottest part of the flame). Without pre-heating, there is a risk that the end of the pipe will shatter into shards when inserted into the flame. *The glass pipe intended for melting must be dry.*

The procedure for making *ampoules* (test tubes) is similar to that for rounding by melting. In

this case, the pipe is rotated in the flame long enough that it is fused at the end – a glass drop closing the original hole is formed. After cooling to laboratory temperature, the product can be poured into the resulting simple test tube. When the product is completely knocked on the bottom of the test tube (*the glass must be clean at the point of intended sealing*), you can start the sealing: keep the base of the test tube in one hand, put a tip of the tweezers into the open hole (mouth) of the tube and begin to heat the part of the tube just below the mouth in the flame. During this heating, rotate the tube continuously so that the glass softens on all sides. Once the glass is softened (slight pressure between your hand and the tweezers bends the tube at the heating point), seal the tube by pulling the neck of the tube away by the tweezers. This pulls out the thin capillary, which easily melts in the flame and seals the test tube.

When *making capillaries*, the closure of the inner hole is undesirable, so the procedure is slightly different: keep both ends of the cut pipe in your hands, and heat the centre of the pipe in the hottest part of the flame. When the glass is softened (this will be shown, among its plasticity, by the intense colouring of the flame), remove the tube from the flame, turn it upright and pull the two ends away from each other with an even pulling (see [Fig. 44](#)). This makes a capillary with uniformly thick walls in the centre of the tube. The process of pulling out should be done as quickly as possible to avoid cooling (and hardening) of the glass. The capillaries are then broken to a suitable length and, if necessary, fused on one side by a flame (the fusing of the capillary is much faster than that of the original tube, since the amount of glass to be melted is much smaller). Attention, glass that has been melted takes a very long time to cool down to a temperature that is tolerable for the human body. Always clean up glass fragments and shards carefully.

4.22 Microsynthesis

The performance of reactions in volumes of reaction mixtures not exceeding 5 ml is called microscale preparation. It is useful to use *syringes* to measure such small volumes of used solvents and reactants.

Microscale reactions are very conveniently carried out in a *vial*. The vial is a small bottle with a screw cap. The cap can be full or with a hole into which a rubber/silicone septum can be inserted. The reactants can be added into the closed reaction mixture using a syringe with a needle pierced through the septum. To avoid pressurizing the contents of the vial when *e.g.* solvent or solutions of reactant is added, the septum must be pierced with an additional (thin) needle to ensure pressure equilibration with the external atmosphere ([Fig. 45](#)).

For isolation of products prepared in the microscale, appropriately small tools should be used – a small plastic frit and a flask with a side tube ([Fig. 45](#)). The sealing of the apparatus for filtration is carried out by a drilled plastic plug or a rubber seal. The suspension of the product is transferred to the frit by a plastic dropper from which the filtered suspension is gradually poured out, while the apparatus is connected to a vacuum source to ensure continuous suction.

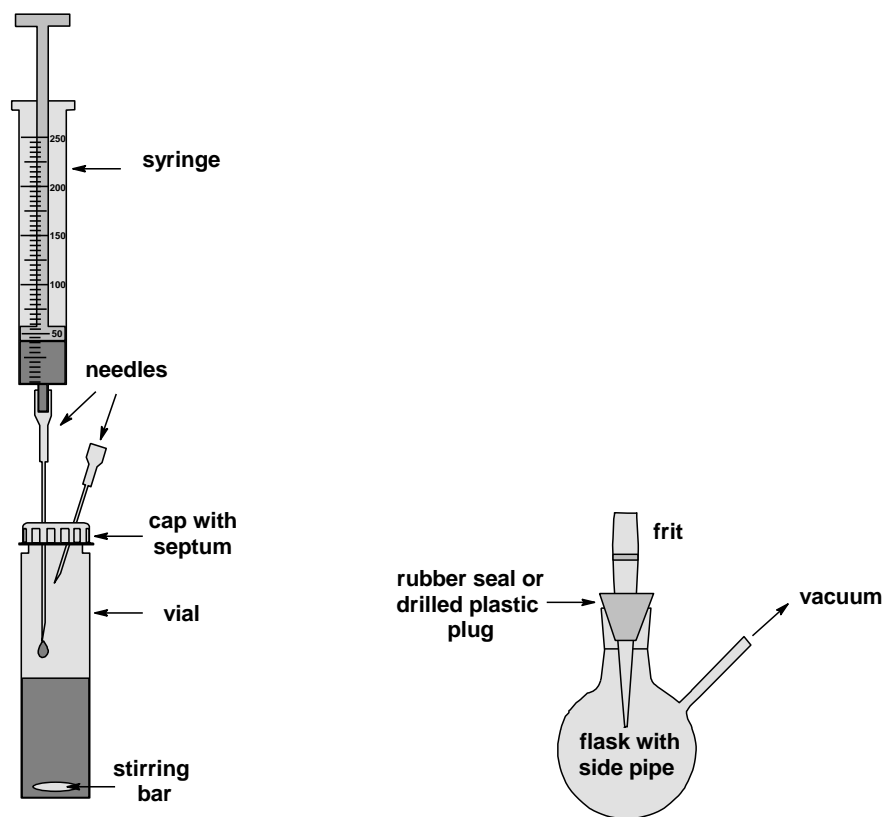

Performance of reaction in a vial

Apparatus for vacuum filtration in a microscale

Fig. 45. Work in microscale.

4.23 Titration

Titration is the determination of the *concentration* (or molar amount) of a substance in a solution. The concentration of solutions can be expressed by many different quantities, such as the *mass fraction* (mass of the solute relative to mass of the solution) or the *molality* (molar amount of the solute relative to mass of the solvent). In analytical chemistry, *molarity* (*molar concentration*, c) is most commonly used. It is calculated as the ratio of the amount of substance n (*i.e.* the number of moles) of the solute to the volume of the solution V (in dm^3):

$$c = \frac{n}{V}.$$

The methods of *volumetric* analysis, which belong to quantitative chemical analysis, are used to study the concentrations or stoichiometric ratios of reactants in *acid-base*, *oxidation-reduction* (*redox*), *precipitation* or *complex-forming* reactions. In titrations, a solution of a titrant is added from the burette and reacts stoichiometrically with the titrated compound (sample) dissolved in the *titration* or *Erlenmeyer flask* (**Fig. 46**). The end of the reaction can be visualized by a colour change of the added indicator, which reacts either with the first excess of added titrant or with the sample, which is consumed during the titration. For acid-base reactions, acid-base indicators are used. An excess of the titrant – acid or base – steeply changes the pH of the solution. This is reflected by a change in the colour of the indicator (an organic dye which behaves like a weak acid or base, and whose protonated and deprotonated forms have very different colours).

The semi-automatic burettes are designed so that when they are filled, the filled volume is automatically aligned to the “0” line (see **Fig. 10**, **Chapter 3.1.18**). The filling of the burette is also “automatic” – the titration solution is pumped through a balloon to create a slight overpressure above the solution level in the storage bottle and the solution is then forced through the capillary into the burette body. When pumping the liquid, it is necessary to close

the hole in the inlet tube with a finger, and when the burette is full, the overpressure is released by opening this hole. The hole must be released in time otherwise the titration solution may splash out of the burette, which can be dangerous if aggressive titration agents (titrants) are used.

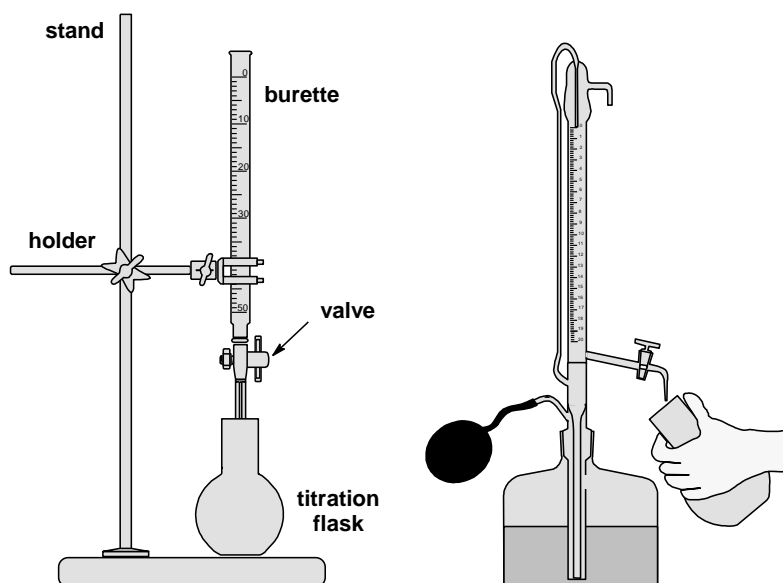

Fig. 46. Apparatuses for titration.

During the titration, use one hand to continuously stir the titration flask and the other to control the rate of addition of titrant from the burette. Volume readings are taken in a similar way as described for pipettes or when filling volumetric flasks, *i.e.* by the line that the meniscus of the titrant touches. If the consumption exceeds the volume of the burette, it is necessary to close the valve when the titration agent reaches the last calibrated line (usually 25 or 50 ml), refill the burette and continue the titration. The total consumption will then, of course, be the sum of all added titrant volumes. However, repeated additions of titrant potentially bring some error to the measurement and it is therefore advisable to adjust the amount of the sample in such way that the consumption does not exceed the total volume of the burette.

4.23.1 Preparation of solution of given concentration

The molar concentration is related to the total volume of the solution, therefore it is not possible to dissolve a given substance in a pre-calculated amount of the solvent, but instead the solvent is gradually added until the desired volume is reached. The *volumetric flasks* are used for this purpose. The solvent is added up to the line on the narrow neck of the flask.

The unit of molar concentration is $\text{mol}\cdot\text{dm}^{-3}$, often referred to as M. The use of symbol of molar concentration c is often replaced by a use of relative concentration (numerically equal to concentration in $\text{mol}\cdot\text{dm}^{-3}$ but unitless). Relative concentration is expressed by a use of square brackets in which the formula of the substance whose concentration is in question is written, *e.g.* [NaOH] is used instead of $c(\text{NaOH})$.

The amount of substance n is equal to the ratio of the weight of the substance m and its molar mass M . The weight of the compound needed for preparation of a solution of concentration c and volume V can be thus calculated by:

$$m = c \cdot M \cdot V.$$

After dissolution of the substance in the volumetric flask and filling the flask to the mark, it is necessary to mix the solution thoroughly – close the flask with a clean stopper and turn it

bottom-up several times. Due to the shape of the flask, the spontaneous diffusion between the neck and the body of the flask is very slow. Use of an unmixed solution is thus a common source of errors (non-reproducible results).

4.23.2 Determination of exact concentration of stock solution

As some compounds used as titration agents are not very well defined, it is necessary to *factorize* the titration solution – *i.e.* to determine the exact concentration of the titrant. For this purpose, the titration of so-called *primary standard* is used – it is a substance which has a high purity (and can be easily purified, *e.g.* by recrystallization), is relatively stable and has a very well defined composition (including a defined stable number of water molecules of crystallization, *etc.*). For example, the concentration of sodium hydroxide (which is often wet on the surface or covered with a carbonate layer) can be determined using selected acidic primary standards such as potassium hydrogen tartrate, potassium hydrogen phthalate, potassium tetroxalate or oxalic acid. Stock solutions of acids can be factorized to basic primary standards such as disodium tetraborate decahydrate, potassium bicarbonate or sodium carbonate. Concentration of a volumetric solution of potassium permanganate can be determined using a well-defined oxidisable substance, *e.g.* Mohr salt (iron(II)-ammonium sulphate hexahydrate).

4.24 Electrolytic processes

4.24.1 Basic principles of electrolysis

Some substances, when dissolved in a suitable (polar) solvent, dissociate into free ions. Such substances are called *electrolytes*.¹ Typical electrolytes are inorganic salts. When an electric current passes through the electrolyte solution, chemical changes occur at the electrodes that supply and drain the current. When ions or molecules come into contact with the *cathode*, *i.e.* the electrode *to which a negative charge is applied from an external source*, they receive *electrons*. The chemical process when the particles accept electrons is called reduction, so **the ions or molecules are reduced onto the cathode**. Conversely, when molecules or ions come into contact with the *anode*, the electrode *from which the negative charge is removed by an external source*, they lose electrons. The chemical process when the particles lose electrons is called oxidation, meaning that **at the anode the ions or molecules are oxidized**. Thus, in electrolysis, we connect the negative pole of an electrical source to the intended cathode, while we connect the positive pole to the anode.²

The quantitative aspects of the chemical transformations that occur on the electrodes and in solution during electrolysis were studied by Michael Faraday in 1813–1835. He formulated his observations in the form of two laws of electrolysis:

1. The amount of substance converted by electrolysis is proportional to the charge passed.
2. The amounts of different substances converted by the same charge are in the ratio of the chemical equivalents of these substances.

The first law of electrolysis is obvious. During electrolysis, a charge Q (in coulombs, C) passing through the solution is given by the product of the current I (in amperes, A) and the

¹ The term “electrolyte” is sometimes used for the material itself, which conducts an electric current based on mobility of ions. The electrolyte is then a solution of a salt (or a melt of a salt), not pure salt in a solid state. The phrase “electrolyte solution” does not make a sense in this case, but on the other hand, it makes possible to define a “solid” electrolyte as a solid phase with ionic conductivity, which is used in material sciences.

² It is worth noting that the polarity of the cathode and anode is reversed at the output of the galvanic cells compared to electrolysis, which can sometimes be confusing. However, a detailed description of the electrochemical processes is beyond the scope of this course, and further details will be given during further study of physical chemistry.

time t (in seconds, s), *i.e.* $Q = I \cdot t$. The amount of substance converted by electrolysis is therefore directly proportional to the time of the electrolysis if the current is constant, or conversely to the current at constant time of electrolysis. This law can be expressed by the equation:

$$m = k \cdot I \cdot t,$$

where m is the weight of converted compound and k is a proportionality constant.

The second law expresses the meaning of the constant k from the previous equation. When one mole of a substance is converted, its mass corresponds to the molecular mass M , and the charge required for the process is given by the product of the charge of one electron ($e = 1,602177 \cdot 10^{-19}$ C), the number of elementary particles in one mole of the compound ($N_A = 6,022142 \cdot 10^{23}$ mol⁻¹), and the number of electrons exchanged during given reaction, z . The product of the constants $e \cdot N_A$ is 96485 C·mol⁻¹. This charge is so-called Faraday constant, F . From the above definition of the value of F it follows that the charge $Q = z \cdot F$ is required to transform one mole of a compound. Weight of the converted compound can be thus calculated by:

$$m = \frac{M \cdot I \cdot t}{z \cdot F}.$$

By comparison with the first Faraday law, it is clear that the constant k in the former equation has the meaning of the weight of the substance that is converted by the charge F (96485 C). In practice, however, in preparative electrolysis, the weight of the product calculated in this way is usually not obtained and the yields are lower than 100% due to the many competing reactions that usually occur on the electrode surface.

Electrolytic oxidation or reduction is in many cases a very convenient method of preparing compounds in which some atom is in a relatively high or low oxidation state.

4.24.2 Galvanic electroplating

Electroplating is a process in which a metal is precipitated from aqueous solutions of its salt by direct current at the cathode in the form of a uniform coating. It serves to protect less noble metals from corrosion or chemical attack, and it is sometimes used to enhance the aesthetic appearance of plated objects. The composition of solutions for such processes (called electrolytic baths) is empirical. These are usually solutions of stable salts of the metal in question, often with the addition of another electrolyte to increase the electrical conductivity of the solution. The experimental conditions are also usually empirical (bath temperature, plating time, voltage, *etc.*). Quantity so-called *current density* is of particular importance for the quality of the formed surface, *i.e.* the current intensity per area of the cathode.

As an example, an aqueous solution of nickel sulphate is considered. The dissociation is described by the equation:

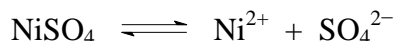

If electrodes are placed in such a solution and an electrical voltage is applied to them, the ions of the electrolyte will be attracted to the oppositely charged electrode. On the cathode, reduction takes place:

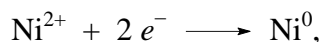

i.e. nickel metal is precipitated. The processes occurring at the anode depend on its material. The simplest case is when the anode is made of the same metal as the cation of the relevant electrolyte, in this case nickel. Then the main process at the anode is oxidation:

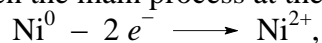

by which nickel ions are added to the solution. Quantitatively, Faraday law applies to such a process.

4.24.3 Electrogravimetry

Electrogravimetry is an analytical method used to determine a number of metals. In this case, the anode is made of a suitable inert material (usually platinum) and cations are therefore not supplied to the solution. At the cathode, the metal ions are quantitatively precipitated from the solution. Again, the conditions for the exclusion of individual ions are empirical and must be followed precisely. By weighing the metal coating the cathode at the end of the electrolysis, the amount (hence the concentration) of the given metal ion in the original electrolyte solution can be determined.

4.25 Absorbance measurement

4.25.1 Absorption spectroscopy

Absorption spectroscopy in the ultraviolet and visible region (UV-Vis region) studies the interaction of matter with electromagnetic radiation in the wavelength range 200–750 nm. This wavelength region can be divided into the near ultraviolet (200–400 nm, “ultraviolet”, UV) and the visible part of the spectrum (400–750 nm, “visible”, Vis). In the visible region of the spectrum, different wavelengths correspond to different colours of radiation (see [Fig. 47](#)).

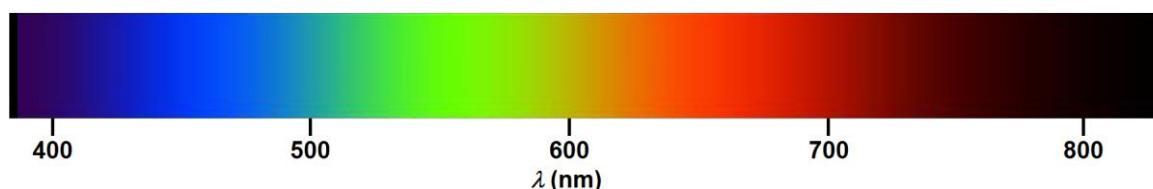

[Fig. 47](#). Dependence of colour of the visible light on its wavelength.

Absorption of radiation in the UV-Vis region is associated with the transition of the molecule from the ground state to the electron excited state. Therefore, the UV-Vis absorption spectrum (the dependence of the magnitude of absorption on wavelength, frequency or wavenumber) reflects the electronic structure of the molecule. The absorption spectrum generally consists of a series of bands which can overlap. Each band corresponds to one electron transition – e.g. transitions between occupied and unoccupied molecular orbitals (the lowest energy of these bands is the HOMO–LUMO transition), transitions between incompletely filled *d* orbitals of the central atom/ion in complex compounds, charge transfer between bonding partners (metal and ligand *etc.*). Different types of electron transitions can be quantum-chemically allowed (or partially forbidden) in different ways, and therefore the probability with which given electron transition occurs can vary very significantly. It leads to different intensities of absorption, and hence to different intensity of colour. If a compound absorbs in the visible part of the spectrum, it is coloured, and its colour appears to our eye to be complementary to the colour of the absorbed light (see [Tab. 1](#)).

The position of the absorption band in UV-Vis spectroscopy is characterised by the wavelength of its maximum λ_{\max} (in nm), the wavenumber $\tilde{\nu}_{\max}$ (in cm^{-1}), or the frequency ν_{\max} (in Hz). The relationships between these quantities and the energy of the photon E_{photon} are:

$$\tilde{\nu} = \frac{\nu}{c} = \lambda^{-1}$$

and

$$E_{\text{photon}} = h \cdot \nu = h \cdot c \cdot \tilde{\nu} = \frac{h \cdot c}{\lambda},$$

where h is Planck constant ($h = 6,626069 \cdot 10^{-34}$ J·s) and c is the speed of light in vacuum ($c = 299792458$ m·s⁻¹). Conversion of wavelength to wavenumber can be done by equation:

$$\lambda(\text{nm}) = \frac{10^7}{\tilde{\nu}(\text{cm}^{-1})}$$

The change in intensity of light when it passes through an absorbing medium is for a given wavelength λ characterized by the *transmittance*, T , as the ratio of the luminous flux passing through the sample (Φ) to the initial luminous flux (Φ_0):

$$T(\lambda) = \frac{\Phi(\lambda)}{\Phi_0(\lambda)},$$

or – more often – by a quantity called absorbance, A :

$$A(\lambda) = \log \frac{\Phi_0(\lambda)}{\Phi(\lambda)} = -\log T(\lambda).$$

A UV-Vis spectrophotometer (see [Chapter 3.5.9](#)) is used to measure transmittance and absorbance.

Tab. 1. The relationship between the wavelength of absorbed light and the corresponding colour of the material.

| λ (nm) | Colour | |
|----------------|--------------|---------------|
| | absorbed | complementary |
| 400–435 | violet | yellow-green |
| 435–480 | blue | yellow |
| 480–490 | cyan | orange |
| 490–500 | blue-green | red |
| 500–560 | green | purple |
| 560–580 | yellow-green | violet |
| 580–595 | yellow | blue |
| 595–610 | orange | cyan |
| 610–750 | red | blue-green |

4.25.2 Lambert-Beer law

The relationship between absorbance, the concentration of the compound in the sample and the thickness of the absorbing medium is expressed by the Lambert-Beer law:

$$A(\lambda) = \varepsilon(\lambda) \cdot c \cdot l,$$

where $\varepsilon(\lambda)$ is the molar absorption (extinction) coefficient at the selected wavelength. It is constant for given compound and selected wavelength and is usually given in units of $\text{dm}^3 \cdot \text{cm}^{-1} \cdot \text{mol}^{-1}$, c is the molar concentration of the absorbing compound in the sample (in $\text{mol} \cdot \text{dm}^{-3}$) and l is the length of the absorbing medium (in cm, in practice the thickness of the cuvette).

The validity of the Lambert-Beer law is verified by measuring the calibration curve, where the measured absorbance values are plotted against the known concentration of the sample solutions. Ideally, a line is obtained which passes through the origin of the coordinate system:

$$A = a \cdot c$$

Sometimes the calibration line is shifted from the origin, *e.g.* when a different cuvette is used for the correction to “zero” absorbance (see [Chapter 3.5.9](#)) than for the actual measurement, or when the measured solution contains other absorbing components that were not present in the blank solution. Then the dependence of the absorbance on the concentration must be corrected by a constant term:

$$A = a \cdot c + b$$

Sometimes, deviation from linear dependence occurs at high concentrations. On the other hand, if the Lambert-Beer law is valid (*i.e.* the dependence of the measured absorbance on the concentration of the detected compound is linear), the concentration of the absorbing compound can easily be determined spectrophotometrically using the measured absorbance. In ideal case:

$$c = A/a,$$

in the case with different background quality between the “blank” and the measured sample, the relation is modified to:

$$c = \frac{A - b}{a} .$$

5. Experimental instructions

5.1 Experiment 1 – Crystallization

Aims

1. Recrystallize a sample of crude acetanilide from hot water.
2. Recrystallize a sample of crude acetanilide from hot toluene.
3. Recrystallize a sample of crude copper(II) sulphate pentahydrate (blue vitriol) by precipitation of aqueous solution with ethanol.

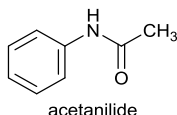

Introduction

Heating

For description of different heating techniques see [Chapter 4.7](#).

Crystallization

For description of different crystallization techniques see [Chapter 4.10](#).

Filtration and vacuum-filtration

For description of different filtration techniques see [Chapter 4.12](#).

Safety note

Used organic solvents (ethanol and toluene) are *very flammable*; perform all manipulations away from sources of ignition

Procedure

Recrystallization of acetanilide from hot water

Weight 2.00 g of crude acetanilide and suspend it in a 250ml Erlenmeyer flask in 70 ml of distilled water. Add a magnetic stirring bar. Put the flask on the magnetic hot plate and place a small glass funnel into the flask's neck. The funnel will work as an air-condenser and reduce evaporation of water from the mixture. Simultaneously, the funnel will be pre-heated, which will prevent crystallization of the product during filtration (if the funnel would be cold, the filtered solution would cool down and any dissolved material would crystallize and block the funnel). With constant stirring heat the mixture to the boiling point of the solvent and boil it for a short period of time (ca. 2 min). Using the pre-heated funnel, filter the hot mixture through folded filter paper into a clean and dry 100ml Erlenmeyer flask. Hold the flask with the hot solution using a piece of fabric or a clamp. If acetanilide crystallizes on the filter paper, pour the suspension back into the 250ml Erlenmeyer flask, add a small amount of water and re-heat to boiling point again. After all of the material dissolves finish the filtration. Close the flask with the filtrate using a plastic stopper³ and cool it in a sink under a stream of cold water. Allow the mixture to stand for 20 min in a fridge to complete the crystallization

³ Pressure decreases in closed apparatus/flasks during cooling. It can lead (in extreme cases) to implosion (when using a big Erlenmeyer flask with a large flat bottom). In addition, when lower pressure develops in the apparatus, it can be difficult to open. Therefore, it is recommended to open the flask several times during cooling to equilibrate the pressure, or to use a poorly fitting stopper.

process. Isolate the crystals by vacuum-filtration on a glass frit. If some solid material remains in the flask, wash it with a portion of the mother liquor from the suction (Büchner) flask. Wash the product on the glass frit with a small quantity of cold water (ca. 10 ml, cool the plastic wash bottle with water in a fridge) and pre-dry it by passing air through the material for 5 min. Collect the product from the frit onto a weighing boat (or a small beaker weighted in advance) using a spatula and place it into a vacuum desiccator. Dry the product under vacuum for ca. 15 min. Weight the pure acetanilide.

Recrystallization of acetanilide from hot toluene

You will work with toxic volatile organic solvent hence work in a fume hood.

Weight 1.00 g of crude acetanilide and place it into a 25ml tear-shaped flask (use a plastic funnel to avoid soiling of the ground glass joint). Place a magnetic stirring bar into the flask and attach the flask to a stand via a clamp. Assemble the rest of the apparatus for heating under reflux (see [Fig. 27](#)). Add 10 ml of toluene into the flask through the condenser. Use a syringe with a needle to measure the required volume of toluene. With constant stirring, heat the mixture in an oil bath to boiling point of the solvent. Remove the apparatus from the oil bath, take off the condenser, unfasten the clamp from the stand with the flask still attached (the clamp will serve as a holder) and filter the hot mixture into a clean and dry 25ml Erlenmeyer flask using a small patch of cotton wool placed in the aperture of a small plastic funnel. Close the flask with a stopper (see note³ on the previous page) and after the mixture is somewhat cooler place it into a refrigerator for 15 min to finish the crystallization process. Isolate the crystals by vacuum-filtration using a glass frit (apparatus: frit + rubber ring + glass adapter + flask), wash the product with 2 ml of toluene (measure the appropriate volume of toluene using a syringe with a needle) and pre-dry it by passing air through the material for 5 min. Collect the product from the frit onto a weighing boat (or a small beaker weighted in advance) using a spatula and place it into a vacuum desiccator. Dry the product under vacuum for ca. 15 min. Weight the pure acetanilide.

Recrystallization of copper(II) sulphate pentahydrate by precipitation of aqueous solution with ethanol

Grind a sample of crude copper(II) sulphate pentahydrate (3.00 g) in a mortar. The grinding of the sample into a fine powder will speed-up its dissolution. One usually adds more solvent than necessary when dissolving large crystals, which results in a solution that is too diluted. Place the ground blue vitriol into a 100ml beaker and dissolve it (with careful stirring by hand) to form a saturated solution (gradually add water in small portions from a plastic wash bottle). Add one drop of 10% aq. sulphuric acid, one small spoon of active charcoal and stir the mixture. Filter the solution through “classically” folded filter paper into a clean and dry 400ml beaker. Precipitate the product from the filtrate by a slow addition of ethanol from a plastic wash bottle while constantly stirring the mixture. Add ethanol until the mother liquor is (after sedimentation of crystals) completely colourless. Isolate the crystals by vacuum-filtration on a frit, wash the product with ethanol and pre-dry it by passing air through the material for 5 min. Spread the product onto a watch-glass (weighted in advance) and weight the pure product after it will be completely dried; check before weighting that all ethanol has evaporated by smelling the sample.

Requirements for acceptance of the results

Weighted products. (Yields cannot be calculated, as we do not know the quantity of the desired compound in the starting mixture.)

Experimental protocol.

5.2 Experiment 2 – Isolation of glycine and identification of unknown amino acid

Aims

1. Isolate free glycine in form of zwitterion from its hydrochloride using ion-exchange chromatography.
2. Identify unknown sample of amino acid by comparative thin-layer chromatography (TLC).

Introduction

Work with rotary evaporator

For description of rotary evaporator see [Chapter 3.5.6](#), for description how to work with see [Chapter 4.9](#).

Precipitation from solution by addition of a bad solvent

For description of this technique see [Chapter 4.10.1](#).

Vacuum-filtration on frit

For description of this technique see [Chapter 4.12.2](#).

Ion-exchange chromatography

In this task, you will isolate amino acid (glycine) in the free form, *i.e.* in form of zwitterion (*betaine*), $^+\text{NH}_3\text{CH}_2\text{CO}_2^-$. Glycine hydrochloride $[\text{NH}_3\text{CH}_2\text{CO}_2\text{H}]\text{Cl}$ will be used as a starting material. You will use strong cation exchange resin in the H^+ -form (see [Chapter 4.16.3](#)). It is polymeric material with strongly acidic sulfonic acid groups ($-\text{SO}_3\text{H}$).

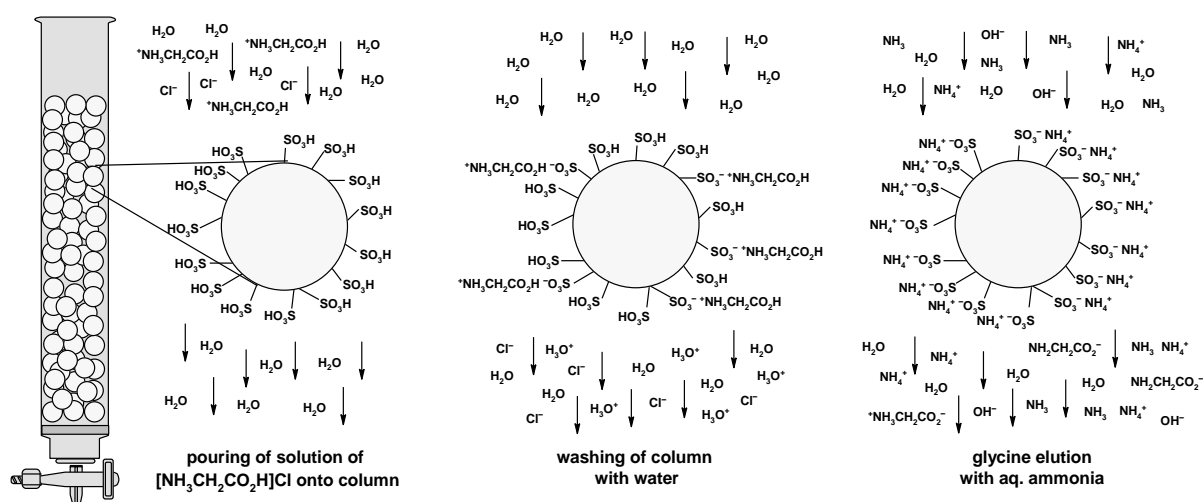
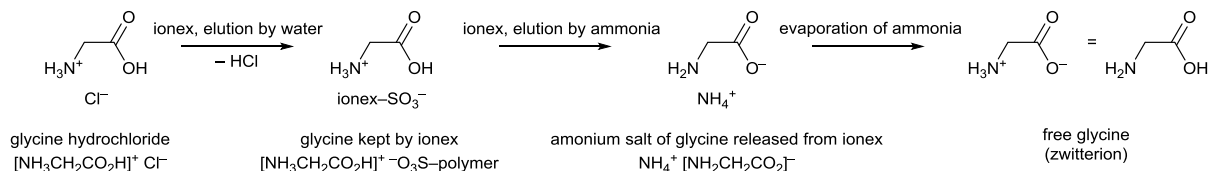

Fig. 48. Schematic representation of separation of glycine from its hydrochloride.

In glycine hydrochloride, both carboxylic and amino functions are protonated, and amino acid is in the cationic form $[\text{NH}_3\text{CH}_2\text{CO}_2\text{H}]^+$. The chloride ion Cl^- serves as a counter-ion. After pouring of solution of glycine hydrochloride onto top of a column of the ion-exchange resin, the protons of sulfonic moieties will be replaced by cations of amino acid, and released HCl will be eluted off the column with water. During water elution, glycine will stay bound to the resin ([Fig. 48](#)). For elution of glycine from the resin, diluted aq. ammonia will be used. It will neutralize a rest of the sulfonic acid groups, and displaces bound glycine due to ammonia excess. The amino acid will be eluted in form of its ammonium salt $(\text{NH}_4)^+[\text{NH}_2\text{CH}_2\text{CO}_2]^-$. By repeated evaporation of eluate you will remove volatile ammonia from isolated amino acid and the product will be precipitated from aq. solution on addition of acetone. Precipitated

product will be isolated by vacuum-filtration on a frit. Ammonium(I) cations bound to the resin will be removed by excess of hydrochloric acid (regeneration of ion-exchange resin) and the excess of acid will be removed by washing the column with water till neutral reaction of an eluate.

Forms, in which glycine is present during whole procedure, are shown in following scheme:



Thin layer chromatography

For description of the technique see [Chapter 4.16.2](#). You will use TLC plates with silica (dried polymeric amorphous and porous gel of silicic acid, SiO₂, containing a large number of surface -OH groups). Surface of silica particles is therefore essentially polar, very hydrophilic, and has an acid nature. From these reasons, the surface has a high affinity to polar compounds, especially towards amines (and in general, towards cationic compounds). Amino acids are therefore bound to a silica surface very strongly, and very polar mobile phase has to be used to move spots of amino acids on the plate. Therefore, the mobile phase should be both acidic (to compete with silica surface -OH groups) or basic (when base present in the mobile phase removes adsorbed compound from the silica surface). In this task you will use the mobile phase containing ammonia. In general, the higher polarity of separated compound, the lower speed of its move. And contrary, presence of hydrophobic moiety in the molecule of separated compound lower overall polarity (and makes interaction of separated compound with silica surface more difficult) and such compounds are moving fast during chromatography.

You will use spraying of the TLC plate with ninhydrin solution for visualisation of the amino acids. Ninhydrin is an agent reacting selectively with amino groups, producing intensive purple colour according to a general scheme:

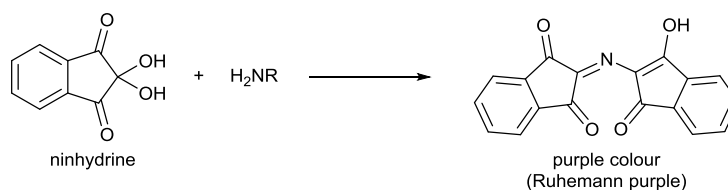

Application of detection agent solution is readily performed by spraying using a sprayer. The spots will be detected upon a gentle heating of the TLC plate in a stream of hot air from a heating gun. Before detection, you have to remove all ammonia from the mobile phase, because ammonia also reacts with ninhydrin and such reaction will disturb detection of the spots. For this reason, you have to evaporate carefully the mobile phase using the heating gun before application of ninhydrin spray. Ninhydrin causes slight irritation (and is slightly toxic) and, therefore, use gloves during the work and hold the TLC plate using a pincer or tongs. Perform a spraying with the detection solution in a sink and wash ninhydrin remains by water into sink-hole.

Procedure

Isolation of glycine

Prepare column of strong cation exchange resin into H⁺-form: wash the column with 25 ml of

the exchanger by 25 ml of 10% aq. HCl. After that wash the column with water until neutral reaction of the eluate (from time to time check pH of the eluate by a strip of pH-paper – small piece of the pH-paper dip in the eluate using a pincer, and compare the colour with a scale on a box with pH-papers). Keep relatively slow rate of elution during washing of the column with HCl (ca. 1 drop per 1 s) to allow a reaching of surface equilibrium between the resin and the eluent. A washing with water (removing HCl excess) can be done much faster. Pour a new portion of water onto a top of the column only after the previous portion is completely soaked. Only in such way you will not dilute remaining acid from above the column – if you would not wait until full soaking, you will have to use much bigger volume of water and whole process will be much longer than needed.

Dissolve 1.00 g of glycine hydrochloride in 10 ml of water. Pour the solution (using a Pasteur pipette or plastic dropper) on top of the ion exchanger. By careful opening of the column's valve set elution speed to ca. 1 drop per 2 s and after soaking of the sample solution wash the column with water till neutrality of the eluate (it will remove HCl). Collect an eluate into Erlenmeyer flask, and check pH of elute time to time with small pieces of pH-paper. In the beginning add water eluent in small portions using washing bottle in such way, that you will wash inside walls of the column. Pour a new portion of water only after a previous portion is fully soaked. Keep a flow rate small in the beginning (1 drop per 2 s), and after addition of several portions of water increase a flow by full opening of the valve to maximum. After washing with water elute glycine with 100 ml of 5% aq. NH_4OH into 250ml round-bottom flask. Also in this case add ammonia in the beginning portion-wise and add a new portion only after the previous is fully soaked to avoid diffusion of released amino acid to column of the eluent above the column of the resin. Evaporate the eluate on rotary vacuum evaporator till dryness, dissolve a remaining material in water, and evaporate volatiles again. This procedure removes ammonia.

Wash the column with water (it will elute remaining ammonia solution which is kept between grains of the resin) and regenerate the resin to H^+ -cycle by washing with 25 ml of 10% HCl and subsequently by water till neutrality. Use time needed for washing of the column and elution of the product for carrying out a TLC analysis of the unknown sample (see below; for sample preparation, dropping of spots, drawing up the TLC plate and detection see [Chapter 4.16.2](#)).

Dissolve solid remaining in the flask in *minimal* amount of water. Pour 80 ml of acetone into a beaker and transfer a solution of glycine into acetone using a plastic dropper. Isolate the glycine by vacuum-filtration on a frit, wash the product by acetone and dry it by sucking an air through the material for 5 min. Weight the pure product and calculate a yield of isolation.

Identification of unknown amino acid

Using TLC on silica plate identify unknown sample of amino acid. Drop on the TLC plate the unknown sample and standards of individual amino acids – glycine, valine, phenylalanine and lysine. For application of the standards on the plate use only dedicated pipetting tips. Do not mix them to avoid mutual contamination of the standards. Use tweezers to operate the pipetting tips. The spots of the standards and the sample should be ca. 2–3 mm in diameter. Use mixture of EtOH:conc. $\text{NH}_4\text{OH}:\text{H}_2\text{O} = 150:6:1$ as a mobile phase, and detect the spots by spraying with solution of ninhydrine. Notice not only positions of the spots, but also colours and colour change during heating of the plate.

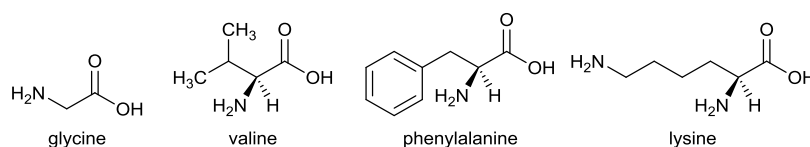

Requirements for acceptance of the results

Weighted pure and dry glycine.

Chromatographic plate with spots of individual amino acid samples and calculated values of retention factor of individual amino acids.

Experimental protocol.

5.3 Experiment 3 – Identification and concentration determination of unknown organic acid

Aims

1. Prepare volumetric stock solution of sodium hydroxide and factorize it (determine its exact concentration) using titration of primary standard, oxalic acid dihydrate.
2. Determine total concentration of protons in solution of unknown organic acid using acido-basic titration with visual detection of equivalence point.
3. Determine dissociation constant pK_{A1} or pK_{A2} of unknown organic acid by potentiometric titration. Identify the unknown acid using determined value of pK_A and calculate its concentration.

Introduction

Work with pH-meter

For description of pH-meter see [Chapter 3.5.5](#), principle of measurement and how to work with is described in [Chapter 4.6](#). Detailed instructions how to measure pH are nearside to pH-meter.

Acido-basic titration

During acido-basic titration, amount of an acid present in the sample is determined using titration with a stock solution of a base (alkalimetry), or contrary, an amount of a base is determined using titration with a stock solution of an acid (acidimetry). During this task you will perform alkalimetric titration of unknown organic acid using phenolphthalein as an indicator.

In general, acido-basic indicator is a compound, which behaves as acid or base (*i.e.* it is protonated/deprotonated during titration), and differently protonated forms thereof are differently coloured. In the case of titration of (generally weak) organic acid by strong alkali hydroxide, the equivalence point⁴ lays in weakly basic region. Therefore, phenolphthalein will be used as an indicator, as it shows a colour change at $pH \approx 8.5-10$. In the case of phenolphthalein, the forms present in acidic and basic solutions have structures shown on following scheme:

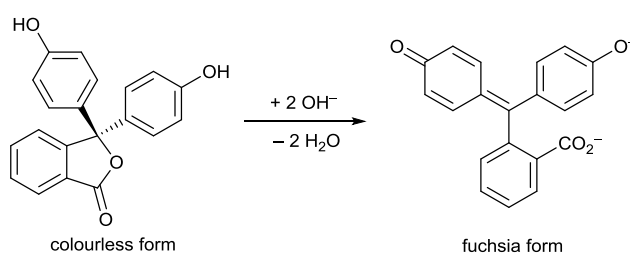

For other details about titrations see [Chapter 4.23](#).

Determination of exact concentration of stock solution

Reaction taking place during determination of concentration (see [Chapter 4.23.2](#)) of NaOH solution using oxalic acid is:

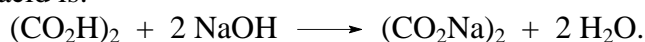

⁴ In the equivalence point, a total molar amount of an acid is equal to a total molar amount of a base, *i.e.* formally, pure salt is present in the solution. However, the solution in equivalence point is not generally neutral (pH needs not to be 7), as due to hydrolysis of cation or anion the concentrations of H_3O^+ and OH^- ions need not to be equal.

After neutralization of all oxalic acid is pH steeply increased with the first drop of excess of titration agent (NaOH) and the mixture changes its colour from colourless to vivid purplish red (pink when very diluted) due to acido-basic indicator added (phenolphthalein). As evident from balanced chemical equation, the molar amount of consumed hydroxide is in the equivalence point doubled with respect to molar amount of oxalic acid:

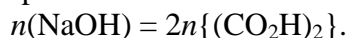

As the mass of oxalic acid will be known and used volume for neutralization [titration agent consumption, $V(\text{NaOH})$] will be read from burette, you can easily calculate the molar concentration of hydroxide using relationship:

$$c(\text{NaOH}) = \frac{2n\{(\text{CO}_2\text{H})_2\}}{V(\text{NaOH})} = \frac{2m\{(\text{CO}_2\text{H})_2\}}{M\{(\text{CO}_2\text{H})_2\} \cdot V(\text{NaOH})} = \frac{2m\{(\text{CO}_2\text{H})_2\}}{126.07 \text{ g} \cdot \text{mol}^{-1} \cdot V(\text{NaOH})}.$$

The used form of oxalic acid is its dihydrate, therefore, corresponding molar mass is already considered in the equation above. Due to a fact, that molar concentration is usually expressed in units of $\text{mol} \cdot \text{dm}^{-3}$, it is necessary to convert volume to appropriate unit (dm^3).

Acido-basic equilibrium

Arrhenius (and Brønsted) acids in aqueous solution undergo a dissociation process according to equation:

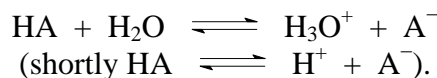

We can define corresponding *dissociation constant* K_A for this equilibrium by equation:

$$K_A(\text{HA}) = \frac{[\text{H}^+] \cdot [\text{A}^-]}{[\text{HA}]}.$$

In general, we can define dissociation constants for any chosen n -degree of m -protic acid H_mA using relationships:

$$K_A(\text{H}_n\text{A}^{(m-n)-}) = \frac{[\text{H}^+] \cdot [\text{H}_{n-1}\text{A}^{(m-n+1)-}]}{[\text{H}_n\text{A}^{(m-n)-}]}.$$

Values of dissociation constants are of different orders, and therefore, for practical reasons, they are tabulated in form of their negative logarithms as $-\log K_A = \text{p}K_A$. If the acid is (nearly) fully dissociated in its aqueous solution (*i.e.* equilibrium in the above-mentioned equation is significantly shifted towards products H^+ and A^-), value of its K_A is $\gg 1$, as can be easily seen from definition of the dissociation constant, and value of $\text{p}K_A$ is negative. For example, HClO_4 and HI belonging to the strongest acids have $\text{p}K_A \approx -10$. Contrary, acids, whose small fraction is dissociated only (*i.e.* above-mentioned equilibrium is shifted towards non-dissociated form HA), have $K_A \ll 1$ and values of $\text{p}K_A$ are positive. Since a number of different acids is very high, a scale of $\text{p}K_A$ is continuous. Acids with $\text{p}K_A < 2$ are called strong, acids with $\text{p}K_A$ in range 2–4 are called medium-strong, in range $\text{p}K_A = 4–9$ are weak acids, and acids with $\text{p}K_A > 9$ are very weak. The lower value of $\text{p}K_A$, the stronger acid is, and better dissociation in aqueous solution occurs.

By logarithm of equation defining dissociation constant we obtain:

$$\log K_A(\text{HA}) = \log[\text{H}^+] + \log[\text{A}^-] - \log[\text{HA}],$$

$$\text{pH} = \text{p}K_A + \log \frac{[\text{A}^-]}{[\text{HA}]}.$$

This equation is called *Henderson-Hasselbalch equation* and finds a wide use in analytical chemistry. It is obvious that if concentrations of dissociated and protonated forms of acid are equal, their ratio is one, and the logarithmic addend in the equation above is equal to zero. Then $\text{pH} = \text{p}K_A$.

Organic acids are typically weak acids. Therefore, concentration of dissociated form A^- which originates from direct dissociation of HA can be neglected. When some base is

gradually added to solution of HA, the species A^- is generated only in such amount which corresponds to amount of added base according to equation:

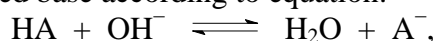

i.e. $[A^-] = [OH^-]$. Condition $[HA] = [A^-]$ is therefore fulfilled in the case, when exactly one half of solution of base needed for full neutralization is added to the solution of acid (one half of acid is neutralized to salt/anion A^- and second half stays in the non-dissociated form HA). Therefore, for weak acids (**attention, only! for weak acids**) one can deduce:

$pK_A = pH$ at point where consumption/volume of the base is $\frac{1}{2}V(\text{ekv.})$.

Typical course of alkalimetric titration of monoprotic acid is shown in [Fig. 49](#). If the base is gradually added to weak acid solution, neutralization occurs and pH of the mixture is slowly increasing. Concentration of A^- is increasing correspondingly. Such a part of titration curve is called *buffering region* – dissolved compound behaves as the buffer – *i.e.* pH is changing only slowly on addition of titration agent (in general acid or base). Near to an *equivalence point* – *i.e.* point, in which added molar amount of the base is exactly the same as original molar amount of the acid – is derivation of the titration curve steeply increased (high pH change), and in the region with a large excess of the base is pH changed again only slowly. From the above-derived equation, pH value at half volume needed for total neutralization correspond to pK_A . Therefore, for monoprotic weak acid, the value of pK_A can be directly read as the pH value corresponding to the half of the hydroxide volume needed for exact neutralization (*i.e.* with respect to equivalence point). From [Fig. 49](#) it is also obvious, that the smallest slope of the titration curve (*i.e.* the highest buffering capacity) is in the solution with pH close to value of pK_A . In calculated distribution diagram, one can see that abundances/concentrations of HA and A^- are equal at $pH = pK_A$.

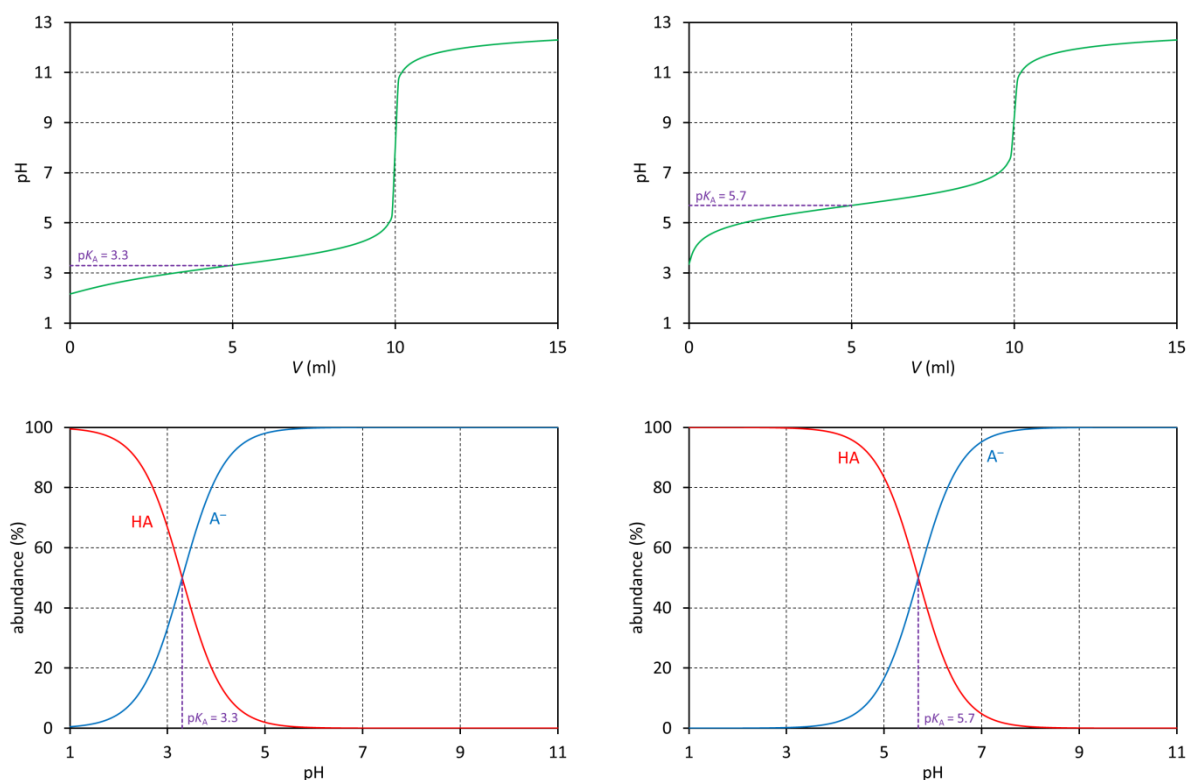

Fig. 49. Titration curve of titration of a weak monoprotic acid HA with a strong base (top), and distribution of HA and A^- species in dependence on pH (bottom). Figures in left column were simulated for $pK_A = 3.3$, figures in right column were simulated for $pK_A = 5.7$. For simulation of titration curves, concentration $c(\text{HA}) = 0.1 \text{ M}$ and volume $V(\text{HA}) = 10 \text{ ml}$ were used. As a titration agent, solution of NaOH with concentration 0.1 M was defined. Equivalence point therefore occurs after addition of 10 ml of titrating agent.

A situation somewhat complicates when working with polyprotic acid. A neutralization of the first proton from electroneutral acid molecule occurs according to equilibrium constant pK_{A1} . After that, the second proton is dissociated/neutralized with pK_{A2} , the third one is dissociated with K_{A3} , etc. In general, $pK_{A1} < pK_{A2} < pK_{A3} \dots$, as the second proton is bound in monovalent anion, and is bound in the acid molecule more tightly due to stronger electrostatic (Coulombic) interaction than the first one, which was bound in the electroneutral molecule. Similarly, the third proton is bound to the acid divalent anion stronger than the second one due to stronger Coulombic interaction, etc. As the value of pK_{An} corresponds to pH, at which exactly one half of given protonation state is dissociated/neutralized, it is obvious, that dissociation of the second proton occurs at higher pH than that of the first dissociation, etc. If difference between pK_A of gradual deprotonations is high, we can see both equivalence steps as consequent waves, as shown in [Fig. 50](#). Sequential deprotonation of the diprotic acid molecule can be seen also from changes of abundance of individual species with increasing pH, as shown in distribution diagram shown in [Fig. 50](#).

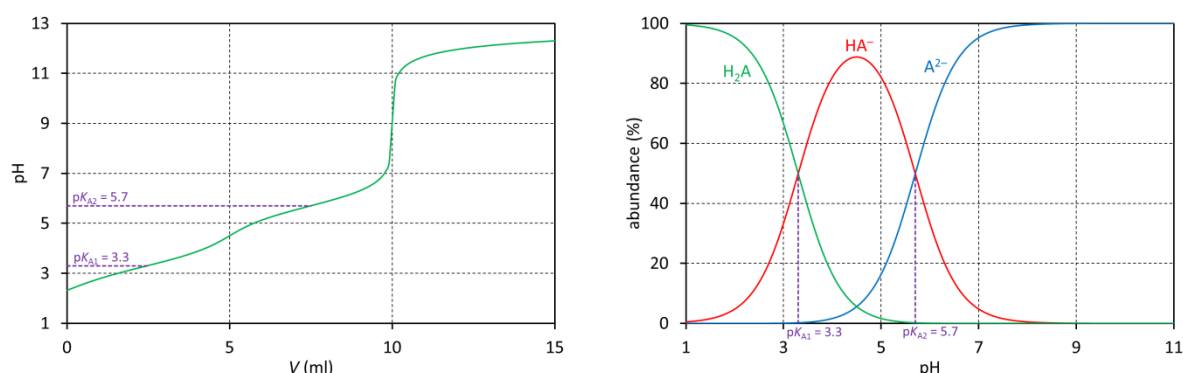
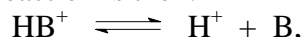

Fig. 50. Titration curve of weak diprotic acid H_2A by strong base (left), and distribution diagram of species H_2A , HA^- and A^{2-} in dependence on pH (right). Figures were simulated for $pK_{A1} = 3.3$ and $pK_{A2} = 5.7$. For simulation of titration curve, concentration $c(H_2A) = 0.05$ M and volume $V(H_2A) = 10$ ml were used. As a titration agent, solution of NaOH with concentration 0.1 M was defined. At $V(NaOH) = 5$ ml, H_2A is neutralized to HA^- , and at $V(NaOH) = 10$ ml, full neutralization to A^{2-} occurs.

From point of view of Brønsted acid/base theory, it is possible to consider protonated base HB^+ as “acids“. Therefore, it is possible to define protonation/dissociation constants even for bases. Corresponding equilibrium reaction is then:



and dissociation constant is defined by relationship:

$$K_A(HB^+) = \frac{[H^+] \cdot [B]}{[HB^+]}$$

Procedure

Preparation of the stock solution of sodium hydroxide

Prepare 250 ml of sodium hydroxide solution with concentration ca. $0.1 \text{ mol} \cdot \text{l}^{-1}$ (see [Chapter 4.23.1](#)): calculate corresponding amount of NaOH and weigh it into a beaker. Dissolve the weighted amount in ≈ 50 ml of water and pour the solution into a 250ml volumetric flask. Fill the flask until a mark at flask’s neck. Close the flask and **mix well its content** by up-down shaking.

Determination of concentration of the sodium hydroxide stock solution

Weigh ca. 0.1 g of oxalic acid dihydrate ($M = 126.07 \text{ g} \cdot \text{mol}^{-1}$) as accurately as possible. The phrase “ca. ... as accurately as possible” means about this value, but with maximal accuracy –

in this case it means to **weigh the standard on analytical balances with accuracy to four decimal places**. Knock down weighed acid into a titration flask and its remains carefully wash by stream of water from washing bottle into the same titration flask – by such procedure you transfer your sample *quantitatively* into the titration flask. Dissolve the oxalic acid in ca. 50 ml of distilled water and add few drops of phenolphthalein solution.

Fill the burette with prepared solution of NaOH (pour the solution carefully and slowly using conic funnel in order to avoid formation of bubbles on the walls inside the burette; place a beaker below the burette). Remove the funnel from top of the burette (some potential drops from the funnel's stem would make an error in the volume read). Carefully drop down the level of titration agent in the burette to zero (to allow bottom of meniscus reach the mark of zero, see [Chapter 4.3](#)). Titrate the solution of oxalic acid with NaOH solution from burette until the mixture will change its colour to purple. In the beginning, the mixture will be purple-coloured in the place of drop's impact, but it will decolorize fast, and during titration a decolourization process will slow down. Therefore, close to end of the titration add solution from the burette in drop-wise fashion and shake intensively. Before end of the titration (when decolourization is very slow) wash walls of the titration flask by distilled water from washing bottle. In an ideal case a colour of titrated mixture will be changed by one drop of the titrating agent. Read volume of the consumed hydroxide and calculate the concentration of NaOH. Perform the titration two more times and calculate averaged value. For further calculations consider the average as the exact concentration. If some value differs from others by more than $\pm 1\%$, repeat the titration once again and do not use the outlying value for averaging. **Do not average weights of the standard and volumes of the titration agent** – in such way you can include also outlying result of titration and the averaged value will not be correct.

Determination of total acidity in the solution of unknown organic acid

Pipette exactly 20.0 ml of unknown acid solution (sample) into a titration flask, and dilute it by further addition of distilled water (≈ 30 ml). Add few drops of phenolphthalein solution. Titrate the sample with factorized solution of NaOH till purple colour similarly as described above. Perform the titration two more times and calculate an average volume, V_{eq} . (In this case, you can average volumes as the pipetted amounts of the unknown acid should be exactly the same, contrary to the case of factorization, where weights of oxalic acid were general and only concentration values could be compared; see above.) If some value differs from others by more than $\pm 1\%$, repeat the titration once again and do not use the outlying value for averaging. Calculate exact concentration of acid protons in the sample.

Calibration of pH-meter



Rinse an electrode by distilled water, dry its bulb carefully by wood pulp and immerse the electrode into neutral buffer with known value of pH. Set intercept of linear function pH on potential (button "Offset") in such way that given pH value will be displayed on the instrument's display. Rinse the electrode by distilled water, dry it using wood pulp and immerse it into an acidic buffer. For displaying of requested pH (pH of the buffer) adjust in this time the slope (button "Slope"). Check if the calibration is appropriate by re-measuring of pH of the first (neutral) buffer – the difference from set value should not exceed ± 0.02 . Always keep the electrode in vertical position and do not leave it in air for unnecessary time – after measurements immerse immediately the electrode into a test tube with water.

Determination of dissociation constant and identification of unknown acid

Pipette exactly 20.0 ml of acetic acid solution (sample) into a small beaker, and dilute it by further addition of distilled water (≈ 10 ml). Put small magnetic stirring bar into the beaker and place beaker onto magnetic stirrer. Rinse freshly calibrated electrode by water, dry it by wood

pulp and immerse it into solution of the sample. If the layer of the solution will not reach electrode frit (bridge to reference electrode), add more distilled water to assure that frit will be under layer of the sample solution (see [Chapter 4.6](#)). *Be careful when immersing electrode into solution to prevent contact of stirring bar with glass membrane of the electrode. It is fragile and can be damaged easily by a stirring bar.* Read pH value. Add 1.00 ml of NaOH stock solution from the burette into titrated sample. Read the value after stabilization of the electrode. In such a way read pH values after gradual addition of 1.00 ml portions of NaOH solution until volume lower by 5 ml than was volume V_{eq} needed for neutralization determined in titration with visual detection using phenolphthalein (see above). In region ± 5 ml around the equivalence point determined in the previous titrations (*i.e.* from $V_{eq} - 5$ ml to $V_{eq} + 5$ ml) use smaller step of added NaOH of 0.50 ml. After that use step of 1.00 ml and add further portions of NaOH until total volume of titration agent $V_{eq} + 15$ ml will be reached. Draw titration curve (*i.e.* dependence of pH on volume of titration agent). Decide from a shape of the titration curve, whether unknown acid is monoprotic or diprotic. If the sample is monoprotic acid, determine its pK_A as the pH value at volume $V_{eq}/2$ (see [Fig. 49](#)). In the case, that unknown acid is diprotic, determine a value of pK_{A2} , see [Fig. 50](#) (value of pK_{A1} cannot be determined from direct reading from titration curve, as possible organic acids are not weak in their first protonation state, and condition $[HA^-] = [OH^-]$ mentioned in Introduction is not fulfilled). Identify by comparison with the values outlined in [Tab. 2](#), which organic acid was present in your sample. Calculate the concentration of the acid from total proton concentration determined by titrations with visual detection of the equivalence point (*i.e.* take into account relation between proton concentration and acid concentration when acid is monoprotic or diprotic).

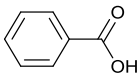
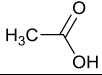
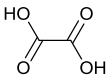
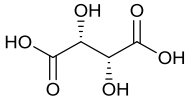
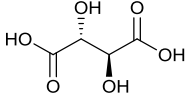
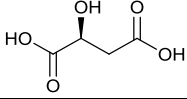
Tab. 2. Values of pK_A of selected organic acids.

| acid | | pK_{A1} | pK_{A2} |
|---|---|-----------|-----------|
| formic |  | 3.75 | – |
| benzoic |  | 4.21 | – |
| acetic |  | 4.76 | – |
| oxalic |  | 1.25 | 3.92 |
| L-(+)-tartaric (2 <i>R</i> ,3 <i>R</i>) |  | 2.89 | 4.40 |
| meso-tartaric (2 <i>R</i> ,3 <i>S</i>) |  | 3.22 | 4.85 |
| malic |  | 3.26 | 5.21 |
| maleic |  | 1.90 | 6.07 |

Requirements for acceptance of the results

Titration curve (dependence of pH on added volume of titration solution of hydroxide).

Value of dissociation constant (pK_A) of unknown acid read from the titration curve.

Identification of unknown organic acid.
Calculated concentration of organic acid.
Experimental protocol.

5.4 Experiment 4 – Determination of melting point

Aims

1. Determine melting points of given samples A and B. Identify these compounds.
2. Determine melting temperatures of mixtures of A and B with content of compound A (by weight) 10, 25, 50, 75 and 90% (content of compound B is complementary, *i.e.* 90, 75, 50, 25 and 10%).

Introduction

Work with melting point apparatus

For description of melting point apparatus and how to work with see [Chapter 3.5.7](#), principle of given measurement is given in [Chapter 4.18](#). Detailed instructions how to measure melting points are nearside to melting point apparatus.

Procedure

Determination of melting points of unknown samples and their mixtures

For measurement of melting points, moisture is undesirable contaminant. Therefore, keep the grinded samples in desiccator when you are not working with them.

Add about 200 mg of sample A into a clean and dry mortar. Grind up it carefully with a pestle and transfer the powdered material onto a small Petri dish or clock glass and put it into a desiccator. Carefully wash the mortar and the pestle by warm water and dry it. Grind about 200 mg of sample B. Pay attention in order to avoid mutual contamination of the samples. Do not forget label Petri dishes/clock glasses to avoid confusion of the samples. Keep the samples in the desiccator until you will start to prepare their mixtures or until filling capillaries with the samples. Weigh appropriate amounts of grinded samples A and B into small vials and prepare their mixtures according to [Tab. 3](#). Weigh with accuracy of tenth of milligram. Use real weights for calculation of exact composition of the mixed samples [*e.g.* if you will weigh 4.7 mg of compound A and 46.2 mg of compound B, you will use real weight fraction $w(A) = 100\% \cdot 4.7 / (4.7 + 46.2) = 9.2\%$ instead of 10%; real composition of the samples should not differ from prescribed values given in [Tab. 3](#) by more than 5%].

Tab. 3. Compositions of mixed samples for determination of melting points.

| sample | weight of A | weight of B |
|--------|-------------|-------------|
| 10 % A | 5 mg | 45 mg |
| 25 % A | 10 mg | 30 mg |
| 50 % A | 10 mg | 10 mg |
| 75 % A | 30 mg | 10 mg |
| 90 % A | 45 mg | 5 mg |

Grind up mixtures item-by-item carefully in a clean and dry mortar – it is necessary to homogenize the mixtures before further measurement. Give the mixtures back into corresponding vials. Clean and dry the mortar and the pestle carefully between grinding of different samples.

Fill capillaries by samples (pure samples A and B and their mixtures containing about 10, 25, 50, 75 and 90% of compound A). Use two capillaries for each sample. Gather up small amount of the powdered samples by open end of the capillary. After that, let the capillary fall down through a long glass tube (about 1 m) positioned vertically onto the floor for several times (about 3×). The sample will be stuffed into a small volume on a bottom of the capillary by moment of inertia and will be heated uniformly. The sample should form about 2 mm high column.

Determine melting point of the prepared samples using melting point apparatus. At first, determine melting point of pure samples A and B. After that, determine melting points of their mixtures. Use average of values obtained for both capillaries with the same sample. Perform individual measurements only after sufficient cooling of the melting point apparatus. Construct a chart of dependence of melting temperature on composition of the samples (*i.e.* use weight fraction of compound A for x axis in scale 0–100%, and depict measured melting points on y axis; similar type of graph is shown in [Fig. 33](#) in [Chapter 4.14.2](#)). Do not forget to include also melting points of pure compounds A and B into the chart.

Remaining samples discard into appropriate container. **Do not give them back into store flasks with pure samples.**

Identify samples A and B by comparison with values outlined in [Tab. 4](#).

Tab. 4. Melting points of selected compounds – possible samples A and B.

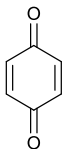
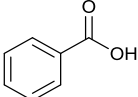
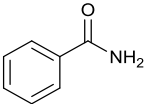
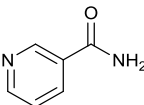
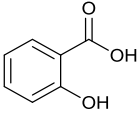
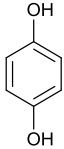
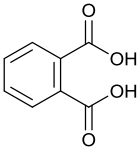
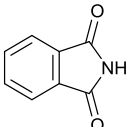
| compound | | t_t (°C) |
|----------------|---|------------|
| benzoquinone |  | 115 |
| benzoic acid |  | 122 |
| benzamide |  | 128 |
| nicotinamide |  | 130 |
| salicylic acid |  | 158 |
| hydroquinone |  | 172 |
| phthalic acid |  | 207 |
| phthalimide |  | 238 |

Requirements for acceptance of the results

Identification of compounds A and B.

Graph showing dependence of melting point on composition of the A–B mixture.

Experimental protocol.

5.5 Experiment 5 – Spectrophotometric quantitative analysis

Aims

1. Measure calibration curve for spectrophotometric determination of concentration of copper(II) ions.
2. Identify the unknown solid sample by determination of copper(II) content.

Introduction

Absorbance measurement

Principle of spectrophotometric measurement and theory is described in [Chapters 3.5.9](#) and [4.25](#). Detailed instructions how to use spectrophotometer are nearside to the device.

Spectrophotometric determination of concentration

Concentrations of copper(II) ions in solution of unknown compound will be determined using Lambert-Beer law (see [Chapter 4.25.2](#)). Concentration of the unknown sample will be determined by comparison of its absorbance with calibration curve (calibration curve is a dependence of absorbance on concentration, *i.e.* line defined by Lambert-Beer law) constructed using series of stock solutions with known concentration of blue vitriol. For this purpose, it is necessary to convert free copper(II) aqua ion, which has only a weak absorption, into strongly absorbing complex tetraammincopper(II) cation with a higher extinction coefficient. Therefore, you will add excess of ammonia into solutions of copper(II) salt.

Procedure

Preparation of standard solutions of blue vitriol

Prepare 5 standard solutions of blue vitriol with concentrations 0.005, 0.010, 0.015, 0.020 and 0.025 M and volume of 10 ml by defined dilution of the stock solution of CuSO₄ ($c = 0.150$ M): pour the stock solution of the blue vitriol into a small clean beaker and measure calculated volumes of the stock solutions using an adjustable automatic pipette (1ml or 5ml) and add the measured amounts into 10ml volumetric flasks. Mark flasks with individual standard solutions using a marker-pen, *e.g.* by labels CuA–CuE. Fill the flasks to mark of 10 ml by distilled water. Mix the standards thoroughly by bottom-up shaking. If it is not possible to measure calculated volume of the stock solution by given automatic pipette, set the closest value and re-calculate concentration of the standard properly. For example:

For preparation of 10.0 ml of 0.0100M standard solution, one needs to pipette such volume of the stock solution of concentration 0.150 M to reach equality of the molar amounts of CuSO₄ in both solutions, *i.e.*:

$$\begin{aligned}n(\text{CuSO}_4) &= c_1 \cdot V_1 = c_2 \cdot V_2 \\(0.010 \text{ M}) \cdot (10.0 \text{ ml}) &= (0.150 \text{ M}) \cdot V_2 \\V_2 &= 0.667 \text{ ml}.\end{aligned}$$

The closest value adjustable on the automatic pipette is 0.650 ml. Therefore, such amount (0.650 ml) is pipetted into 10ml volumetric flask, giving exact concentration of the final standard solution:

$$c_1 = \frac{c_2 \cdot V_2}{V_1} = \frac{0.150 \text{ M} \cdot 0.650 \text{ ml}}{10.0 \text{ ml}} = 0.00975 \text{ M}.$$

Calculate other required amounts of the stock solution needed for preparation of remaining standard solutions in a similar way.

Pour prepared solutions of standard concentrations into dry and clean vials labelled with marker as CuA–CuE. Using the automatic pipette, measure 5.00 ml of each standard into a set of new clean vials labelled CuST1–CuST5. To these solutions, add 1.00 ml of 5% aq. ammonia (measure this volume by 1ml automatic pipette). Close the vials and mix the content

thoroughly. Prepare the reference – measure 5.00 ml of distilled water and 1.00 ml of 5% aq. ammonia into a vial labelled REF, close the vial and mix its content.

Preparation of solution of the unknown sample

Weight (on the weighing boat) ca. 75 mg of the unknown sample as accurately as possible. The phrase “ca. ... as accurately as possible” means about this value, but with maximal accuracy – in this case it means to **weigh the standard on analytical balances with accuracy on four decimal places**. Wash the solid sample by small amount of distilled water from washing bottle into a clean 25ml volumetric flask (use a glass funnel) and dissolve it by gentle shaking. Fill the volumetric flask to the mark, close it and **carefully mix the content** by bottom-up shaking for several times. Pour part of the solution into a clean and dry vial. Measure 5.00 ml of the solution using an automatic pipette into a new clean and dry vial labelled CuVZ. Add 1.00 ml of 5% aq. ammonia (using 1ml automatic pipette), close the vial and shake the content.

Selection of optimal wavelength for spectrophotometric measurement

Wash two cuvettes. Pour reference solution (REF) into the cuvettes – fill the cuvettes using a plastic dropper to reach level about ≈ 6 mm below an upper rim of the cuvette. Insert the cuvettes in the sample holders – one into the holder labelled “M” (“measure”), the second into the holder labelled “R” (“reference”). Take care about orientation of the cuvettes – they must be oriented in the beam by their shiny side. Measure baseline (“blank”) in the range 450–750 nm using a step of 1 nm – *i.e.* device will compare absorbance of both cuvettes with the same solvent and will set zero absorbance. Empty the cuvette from the “M”-holder and wash it 2 \times with the first measured sample – it will be the Cu(II) standard with the highest concentration. Fill the cuvette with the standard and place it back in the holder.

Measure a spectrum of blue vitriol in aq. ammonia (*i.e.* tetraammincopper(II) sulphate) under the same conditions as “blank” was measured (*i.e.* in the range 450–750 nm using a step of 1 nm). Observed absorbance is depicted automatically by the device on its display as a function of the wavelength (*i.e.* as *absorption spectrum*). Export data to ASCII/CSV format and treat the exported file using suitable table editor (Excel, Origin, *etc.*) to create a spectrum. *Spectrum is mandatory part of the protocol*. Optimal wavelength for further measurements is a wavelength of the absorption maximum – at this wavelength is the maximal response of the spectrophotometer to change in concentration.

Construction of calibration curve

Determine absorbance of all standards at the wavelength corresponding to the absorption maximum. Measure at first absorbance of the most concentrated standard solution. Empty the cuvette, wash it 2 \times with a new solution of the closest lower concentration, fill the cuvette and measure absorbance again. Proceed this way for all other remaining standard solutions. This method will reduce possible errors originating in non-perfect replacement of the old standard by the new one.

Construct a calibration curve (line) using suitable table editor. Use the editor for calculation of linear regression of the data-points (*e.g.* in Excel, mark the data-points series, and choose “Chart” \rightarrow “Add trend-line” – it will calculate the regression line; the parameters of the line can be displayed by editing of dialog tab window by cross-checking “Display equation” and “Display value of R ”). Calculate concentration of the unknown sample from the equation of regression. *Calibration curves must be shown in the protocol*. The line should be going through the origin [0,0], as absorbance of solution with zero concentration of the determined compound should be zero. Therefore, fix the point [0,0] in the regression (set in tab window “Value $Y = 0.0$ ”).

Determination of copper(II) concentration in the solution of the unknown sample and its identification

Measure absorbance of solution of the unknown sample at wavelength chosen for construction of the calibration curve. Of course, modify the sample of blue vitriol in the same way as was used for standard solutions (defined addition of ammonia solution). Calculate concentration of the unknown sample using the calibration curve. From the concentration and known weight of the sample calculate weight fraction of the copper in the sample and molar mass of the sample. Using data from [Tab. 5](#) identify the unknown sample.

Tab. 5. Copper(II) salts – possible unknown samples.

| compound | w_{Cu} (%) | M_r |
|--|---------------------|--------|
| $\text{CuCl}_2 \cdot 2\text{H}_2\text{O}$ | 37.28 | 170.48 |
| $\text{Cu}(\text{CH}_3\text{CO}_2)_2 \cdot \text{H}_2\text{O}$ | 31.83 | 199.65 |
| CuBr_2 | 28.45 | 223.35 |
| $\text{CuSO}_4 \cdot 5\text{H}_2\text{O}$ | 25.45 | 249.68 |

Requirements for acceptance of the results

Absorption spectrum of solution of tetraammincopper(II) sulphate (blue vitriol in presence of ammonia excess).

Calibration curve – dependence of absorbance of standards on concentration – and a value of extinction coefficient in absorption maxima.

Calculation of molar concentration of solution of the unknown sample.

Identification of the unknown sample.

Experimental protocol.

5.6 Experiment 6 – Electrolytic preparation and electrogravimetry

Aims

1. Prepare potassium peroxodisulphate by anodic oxidation of solution of potassium sulphate in sulphuric acid and test its reactivity according to instructions.
2. Coat metal sheet by electroplating with copper; verify validity of Faraday's law by determination of relative atomic mass of copper.
3. Use copper-coated sheet as cathode for electrogravimetric determination of molar concentration of nickel in sample solution.

Introduction

Theoretical introduction to electrochemical reaction see [Chapter 4.24](#).

Vacuum-filtration

For description of this technique see [Chapter 4.12.2](#).

Electrolytic preparation

This preparation is a typical example of electrolytic oxidation (anodic oxidation). Anode is made of platinum sheet, the solution of potassium sulphate in 41% sulphuric acid is used as electrolyte. By passage of electric current, the reaction proceeds:

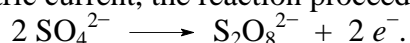

Electroplating

This method is used for plating cathode – metal sheet – by layer of copper. Electroplating will be done for given time using known electric current, so, you will know total charge passed through system. After weighting of formed copper layer you will be able (using Faraday's law) determine its atomic weight (see [Chapter 4.24.1](#)).

Electrogravimetry

Copper-coated sheet will be used as cathode for electrogravimetric determination of nickel. After weighting of nickel you can calculate its concentration in the given sample.

Procedure

Preparation of potassium peroxodisulphate

Build the apparatus according to [Fig. 51](#). Add head of electrolyser (with electrodes) onto bottom part of apparatus. Surface of joint connection cannot be greased by usually used Ramsay grease or Vaseline (petroleum jelly), but only by silicon grease (there is possibility of grease's ignition during work with strong oxidizing agents). Attach the electrolyser by clamp (*using the bottom part*) to the stand and place it into Dewar vessel as low as possible. *Be careful when manipulating with Dewar vessel – risk of implosion.*

Polyethylene tube from bubble counter attach to glass pipe in electrolyser's head (use the glass tube which ends above level of electrolyte). Attach tube connected with pipe in window's frame (far from burners) to the other glass pipe in the head of electrolyser. It avoids a potential explosion, as mixture of hydrogen and oxygen is formed in side-reactions during electrolysis.

After assembly of apparatus and connection of wires ask teachers to check your apparatus and connection. Only after successful check ask for electrolyte, dry ice and ethanol for cooling (electrolyte and ethanol are kept in freezer; if you ask for them earlier, they warm up unnecessarily). Fill the bottom part of the electrolyser by electrolyte using hole in its head (by funnel) till level of electrolyte is about 25 mm below the end of pipe with air inlet. Switch on

the bubbler – it will flow the air into your apparatus, and blow out all gaseous by-products occurred during reaction.

Pour cool ethanol into Dewar vessel till level of ethanol will be slightly above a level of electrolyte inside the apparatus. Add crushed dry ice portion-wise into ethanol to adjust temperature of the bath in range from $-20\text{ }^{\circ}\text{C}$ to $-25\text{ }^{\circ}\text{C}$. The electric source is still switched off. Only after reaching the required temperature start the electrolysis, and keep temperature in this range during whole electrolysis. Set optimal experimental conditions: current 1.5 A (exactly), the potential should be in range 6–10 V. *It is forbidden to manipulate with electric contacts and disassembling the apparatus during electrolysis (when electrical source is on).* Switch off the source after one hour of electrolysis, disconnect wires from head of electrolyser, and disconnect also both tubes. Place off the electrolyser from the Dewar vessel and disassemble the apparatus.

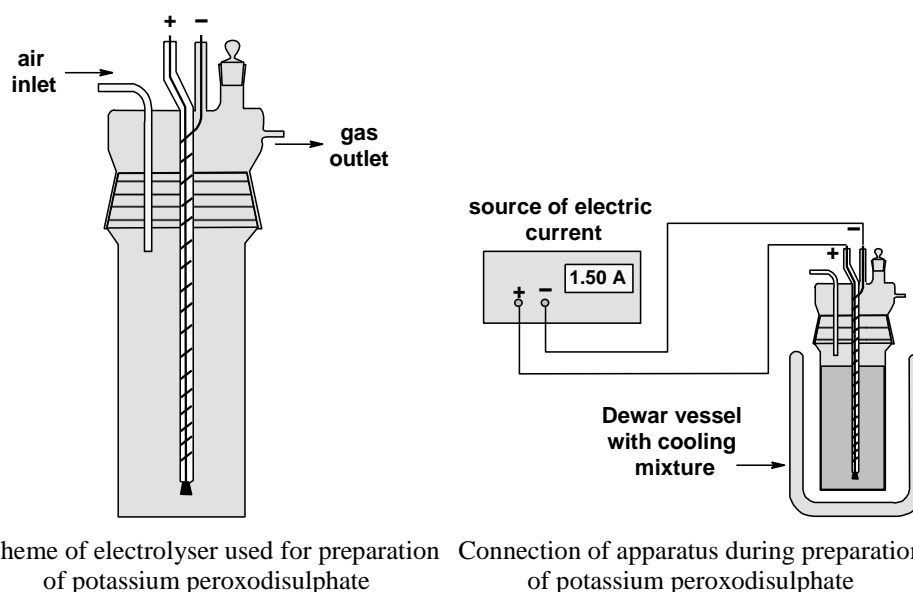

Fig. 51. Apparatus for preparation of potassium peroxodisulphate.

Isolate precipitated peroxodisulphate by vacuum filtration on a glass frit. Collect the filtrate into clean and dry filtration flask and pour it back to stock bottle. After this wash collected peroxodisulphate by ethanol; in this case discard the filtrate. *There must not be any ethanol in the stock bottle.*

Wash both parts of the electrolyser by water and let it dry on the plate. Dry washed product by air-flow on the frit. Weight the product and calculate (using Faraday's law) theoretical yield of your preparation (change following equation with respect to real values of time of electrolysis and electrical current):

$$m(\text{K}_2\text{S}_2\text{O}_8) = \frac{M(\text{K}_2\text{S}_2\text{O}_8) \cdot I \cdot t}{z \cdot F} = \frac{270.32 \text{ g} \cdot \text{mol}^{-1} \cdot 1.50 \text{ A} \cdot 3600 \text{ s}}{2 \cdot 96485 \text{ C} \cdot \text{mol}^{-1}}$$

Calculate the yield of your preparation.

Reactions of potassium peroxodisulphate

Perform these reactions with your product:

a. Add ca. 3 ml of 5% solution of potassium iodide into a test tube. Add ca. 0.5 ml of 10% H_2SO_4 . Add 0.1–0.2 g (one half of small lab-spoon) of prepared solid peroxodisulphate. Heat the mixture carefully on the gas burner.

b. Add 0.1–0.2 g of prepared solid peroxodisulphate into a test tube and add ca. 3 ml of

manganese(II) sulphate solution in 10% H₂SO₄. Add few drops of 5% silver(I) nitrate solution (catalyst). Heat the mixture carefully on the gas burner.

c. Repeat both reactions above, but now using ca. 0.5 ml of 10% solution of hydrogen peroxide instead of K₂S₂O₈. Make notices about your observation, balance corresponding equations and compare oxidation abilities of peroxodisulphate and hydrogen peroxide.

Determination of relative atomic mass of copper

Wash the metal sheet by immersing into 6M nitric acid for 5 s. Wash the sheet by water (firstly from water tap, after by distilled water and finally by ethanol) and let it dry on a clock glass in drying oven. Determine the weight of the metal sheet (after cooling to room temperature). You are going to do analytical experiment, so use analytical balances. Use tweezers when washing and manipulating with the sheet – do not touch it by fingers.

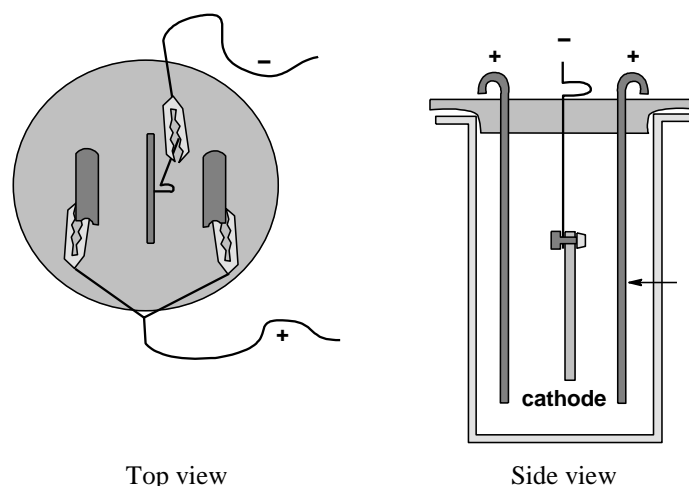

Fig. 52. Apparatus for electrochemical plating and electrogravimetry.

Assemble an apparatus according to **Fig. 52**. Use cover of the electrolytic cell with linear holes for anodes. Place supply wire of the cathode into the central hole in the cover (from bottom side) and after bended part of the wire is passed through the cover turn it by 90° in such way that the cathode will be hanged in the hole. Place copper anodes into side holes. Pour coppering solution into the cell; the bolt joining the cathode with the supply wire should be about 2 cm above layer of the coppering solution. Connect clips of supply wires of the electric source to head parts of the anodes and to supply wire of the cathode (take care about right polarity of the electrodes) and copper the cathode using current of 0,50 A for 20 min. A voltage should be relatively low, < 1 V. If not, *check (with circuit switched off) all contacts*. You need to know exact value of current and time for calculation of exact charge passed through during electrolysis.

After 20 min switch off the source, disconnect the clips and get off the cover from the bath. Wash the electrodes (still hanged in the cover) in a sink by water. Take off the electrodes and wash them again by sink water, distilled water and finally by ethanol. Dry the cathode in drying box and (after cooling to room temperature) determine its weight. Pour coppering bath back into a stock bottle. Calculate mass of the copper. Determine relative atomic mass of copper using Faraday's law:

$$A_r = \frac{m \cdot z \cdot F}{I \cdot t} = \frac{m \cdot 2 \cdot 96485 \text{ C}}{0,50 \text{ A} \cdot 20 \cdot 60 \text{ s}}$$

and discuss the difference between your value and tabulated value ($A_r = 63.54$).

Electrogravimetric determination of concentration of Ni^{2+} in unknown sample

Wash the apparatus thoroughly by distilled water. Pipet 10.0 ml of the sample into the apparatus. Dilute the sample by distilled water to ca. 80 ml and add 5 g of solid $(\text{NH}_4)_2\text{SO}_4$ and 20 ml of 25% ammonia. The sulphate will play a role of basic electrolyte, which will ensure the flow of electric current. *Use cover of the electrolytic cell with round holes for anodes.* Place the cathode into the central hole in the cover of the electrolytic cell, similarly as in the previous case. Place platinum anodes into side round holes (anodes will be handed out by a lab assistant immediately before a work). Connect clips of supply wires of the electric source to head parts of the anodes and to supply wire of the cathode and perform the electrolysis using potential ~ 10 V for 60–90 min. The end of electrolysis is indicated by complete electro-deposition of nickel, *i.e.* no nickel(II) is detectable in the solution using diacetyldioxime: put one drop of electrolysed sample solution onto clock glass, add one drop of solution of diacetyldioxime and mix the mixture by a glass rod. Diacetyldioxime forms with nickel(II) ions intensively red precipitate according to scheme:

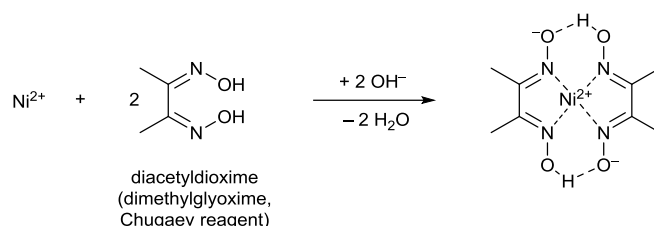

Let the electrolysis until red colour is formed during such check. Chugaev reaction is very sensitive, so weak pink solution (not a precipitate!) is acceptable at end of the electrolysis. Switch off the electric source and get off the ring top from the bath. Take off the metal sheet, wash it by water and ethanol, dry it in drying box and (after cooling to room temperature) determine its weight. Platinum electrodes give back to the lab-assistant, electrolyte solution pour into waste sink.

From mass of formed nickel determine the concentration of nickel(II) ion in original sample solution:

$$c = \frac{n}{V} = \frac{m}{M \cdot V} = \frac{m}{58,69 \text{ g} \cdot \text{mol}^{-1} \cdot 0,0100 \text{ dm}^3} .$$

Requirements for acceptance of the results

Prepared potassium peroxodisulphate with calculated yield.

Performed reactions with prepared peroxodisulphate and balanced equation of observed processes.

Calculated relative atomic mass of copper.

Electrogravimetrically determined nickel(II) concentration in the sample.

Experimental protocol.

5.7 Experiment 7 – Determination of distribution coefficient of iodine

Aims

1. Determine distribution coefficient of iodine in chloroform : water mixture.
2. Determine distribution coefficient of iodine in toluene : water mixture.

Introduction

Separation of non-miscible liquids

For description of this technique see [Chapter 4.13](#).

Titration

For details about titrations see [Chapter 4.23](#).

Distribution coefficient

The ratio of concentration of compound dissolved in individual phases of non-miscible solvents is at given temperature and pressure constant and is called *distribution coefficient*, K' . Distribution coefficient describes relative affinity of given compound towards two mutually non-miscible solvents.

In this task you will determine distribution coefficient of iodine between organic solvent and water. You will use two organic solvents – chloroform and toluene, so you will determine two distribution coefficients:

$$K'(\text{CHCl}_3/\text{H}_2\text{O}) = \frac{[\text{I}_2(\text{CHCl}_3)]}{[\text{I}_2(\text{H}_2\text{O})]}$$

and

$$K'(\text{toluene}/\text{H}_2\text{O}) = \frac{[\text{I}_2(\text{toluene})]}{[\text{I}_2(\text{H}_2\text{O})]}.$$

The content of iodine will be determined by titration (see [Chapter 4.23](#)). In volumetric analysis, the process called iodometry employs redox half-reaction $\text{I}_2 + 2 e^- \rightleftharpoons 2 \text{I}^-$. Iodometry includes a number of different determinations, employing selective reaction between iodine and sodium thiosulfate producing sodium iodide and sodium tetrathionate according to equation:

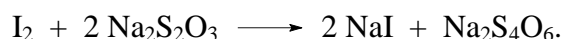

Iodine forms an intensively blue complex with starch, which decolourization indicates quantitative course of the reaction. Therefore, the amount of iodine can be determined by titration with thiosulfate. In the equivalence point, following equation is valid:

$$n(\text{S}_2\text{O}_3^{2-}) = 2n(\text{I}_2).$$

After careful mixing of two layers in the separation funnel (see [Chapter 4.13](#); thorough shaking is needed for establishing of equilibrium) and their separation, it is possible to determine concentration of iodine in individual solvents/phases by titration and to calculate the distribution coefficient.

Procedure

Determination of distribution coefficient of iodine in chloroform : water mixture

Place approx. 0.3 g of iodine into 100ml Erlenmeyer flask and dissolve it in ca. 50 ml of chloroform. Filter the solution through a *small* cotton plug placed in the funnel into a 250ml separation funnel (you will remove potential remains of unsolved iodine or impurities). Add

170 ml of water, close the funnel and shake the mixture thoroughly. Allow perfect separation of the layers by standing. Separate lower (chloroform) layer into clean and dry 100ml Erlenmeyer flask, and *close it* by a stopper. Pipette 50.0 ml of aqueous (upper) layer from separation funnel into 250ml titration flask, add 10 ml of diluted aq. hydrochloric acid (1 : 1) and 0.5 g of potassium iodide (it forms triiodide anion with iodine, and triiodide forms with starch used in the end of the titration more intense colour than iodine itself, and the equivalence point is better visible). Titrate by stock solution of thiosulfate ($c = 0.002 \text{ M}$) to light yellow colour (almost to decolourization). Add 1 ml of starch solution and titrate the blue mixture to decolourization. Repeat the titration. If consumptions of both determinations differ more than by $\pm 0.5 \text{ ml}$, perform the titration once more. Calculate concentration of iodine in aqueous layer based on average consumption. Due to a stoichiometry of the reaction, one can derive that:

$$n(\text{I}_2, \text{H}_2\text{O}) = \frac{1}{2} \cdot n(\text{S}_2\text{O}_3^{2-}) = \frac{1}{2} \cdot c(\text{S}_2\text{O}_3^{2-}) \cdot V(\text{S}_2\text{O}_3^{2-}),$$

and thus:

$$c(\text{I}_2, \text{H}_2\text{O}) = \frac{n(\text{I}_2, \text{H}_2\text{O})}{V(\text{I}_2, \text{H}_2\text{O})} = \frac{c(\text{S}_2\text{O}_3^{2-}) \cdot V(\text{S}_2\text{O}_3^{2-})}{2 \cdot V(\text{I}_2, \text{H}_2\text{O})}.$$

Measure 1.00 ml of chloroform phase using the syringe and add the sample into the titration flask containing ca. 50 ml of water, acidify by 10 ml of diluted aq. hydrochloric acid (1 : 1) and add 0.5 g of potassium iodide (besides of better visualization of the end of the titration mentioned above it also improves the solubility of iodine in aqueous phase, in which will proceed the reaction with thiosulfate – therefore, the reaction between iodine and thiosulfate will proceed much faster). Titrate by analogous way as in the previous case until decolourization of iodine–starch colour. Repeat the determination once more time. If consumptions of both determinations differ more than by $\pm 0.5 \text{ ml}$, perform one more titration. Calculate concentration of iodine in the organic layer based on average consumption similarly as in the previous case. Remaining organic phase pour into to this purpose dedicated bottle. Finally calculate distribution coefficient of iodine between chloroform and water using equation mentioned above.

Determination of distribution coefficient of iodine in toluene : water mixture

Perform this determination analogously using 50 ml of toluene instead of chloroform. The difference will rise from lower density of toluene comparing to water – the organic layer will be the upper one. Pour the aqueous layer into 250ml Erlenmeyer flask, and keep the toluene layer in the separation funnel.

Requirements for acceptance of the results

Calculated value of distribution coefficient of iodine in chloroform : water mixture.

Calculated value of distribution coefficient of iodine in toluene : water mixture.

Experimental protocol.

5.8a Experiment 8a – Rectification

Note: This task is carried out together with the Experiment 8b.

Aims

1. Separate ethyl-acetate and toluene by rectification. Construct chart of time dependence of the boiling point. Determine refractive index of individual fractions.
2. Based on these data, estimate the ratio of ethyl-acetate and toluene in the sample.

Introduction

Rectification

Principle of rectification (fractionation) is described in [Chapter 4.14.2](#).

Refractive index determination

Description of refractometer and how to work with is given in [Chapter 3.5.8](#), principle of the measurement is described in [Chapter 4.19](#). Ask the teacher for explanation how to operate the refractometer.

Procedure

Separation of mixture of ethyl-acetate and toluene by rectification

Distillation apparatus according to [Fig. 34](#) in [Chapter 4.14.2](#) is already assembled; do not disconnect individual parts of the apparatus.

Pour 100 ml of the distillation sample into 250ml round-bottom flask. Add pieces of porcelain and connect the flask with distillation column and fix it by a clamp. Move the heating nest up to fit it closely to the flask.

Switch on the cooling water with such intensity that it will be possible to recognize individual blades of flowmeter (or it will be possible to recognize colours of individual balls if ball flowmeter is used). Make sure, that valve of distillation head is closed (reflux valve) and arrange set of test tubes for collection of the individual fractions (label test tubes by numbers 1–8).

Switch on the heating nest (turn on both switches for bottom and upper parts of the nest) and set it to maximal power. Make sure that warning light is lighting. Monitor starting of boiling and reaction of the thermometer in the distillation head. After first drops appear in the distillation head, let the column to equilibrate for 5 min (reflux valve is still closed).

After equilibration of the column open the reflux valve to let distillate drop off from the head by 2 drops per 1 s. Collect 10 ml of individual fractions into the test tubes. Monitor the boiling temperature in 1 min intervals, and compile the temperatures in the table. Make a notice when changing the test tubes.

Switch off the heating nest when you collected 75 ml of the distillate, *i.e.* when there is 5 ml of liquid in the test tube no. 8. By thermal capacity it will fill some remaining liquid. In the round-bottom flask, there should be remaining ca. 20 ml of residue after cooling of the apparatus. Disconnect the distillation flask from the column.

Before measurement of refractive indexes of collected fractions and distillation residue check out your work technique with refractometer by determination of refractive index of etalons (pure ethyl-acetate and toluene), and report them to a teacher. After verification of your work determine refractive indexes of each fraction and of the distillation residue.

After identification of individual fractions pour the fractions into corresponding battles. Pour also distillation residue into a dedicated bottle. Wash the distillation flask with ethanol (washing can be poured into a sink). Employing suitable table editor, construct chart of the distillation – *i.e.* dependence of boiling point on time and show areas where individual

fractions were collected. Based on acquired data, estimate the ethyl-acetate/toluene ratio in the starting sample.

Requirements for acceptance of the results

Chart showing course of distillation – dependence of boiling point on time.

Refractive indexes of etalons, individual fractions and distillation residue.

Ratio of ethyl-acetate and toluene in the starting mixture.

Experimental protocol.

5.8b Experiment 8b – Work with gases

Note: This task is carried out together with the Experiment 8a.

Aim

1. Determine content of calcium(II) carbonate in the sample of a marble.

Introduction

Work with gases

In a number of chemical reactions, some gases are evolved. In our case, we will measure amount of CO₂ evolved during reaction of hydrochloric acid with sample of marble:

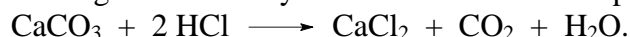

Based on volume of evolved gas (CO₂) we will determine carbonate content in the sample for chemical analysis. It is based on ideal gas law (general gas equation):

$$p \cdot V = n \cdot R \cdot T,$$

where p is pressure (in pascals, Pa), V is volume (in m³), n is molar amount of the gas (in moles, mol), R is ideal gas constant (8.314 J·mol⁻¹·K⁻¹) and T is thermodynamic temperature (in Kelvins, K).

From this equation, it is obvious, that at given temperature and pressure, 1 mol of each gas occupies the same volume, independently on the nature of the gas. The volume is extremely sensitive to temperature and pressure. Students often make errors by suggestion, that 1 mol of the gas occupies volume of 22.4 dm³. It is valid only for *normal conditions*, defined as *normal pressure* (101325 Pa) and *temperature* 0 °C (273.15 K), but not temperature 25 °C (298.15 K), usually suggested as laboratory/room/ambient temperature. At room temperature, 1 mol of the ideal gas occupies 24.5 dm³, as can be easily confirmed by a calculation. Therefore, before any simplified calculations with using of „molar volume“, think, if all assumptions for its value were fulfilled.

The simplest way how to determine volume of evolved gas is using of *eudiometer*. It is calibrated cylinder filled by a closing liquid, which is immersed in bottom-up fashion in a glass bath containing closing liquid (water is used in our case). The volume can be directly read on the cylinder as it is equal to volume of water pushed out from the cylinder. If heights of water in the cylinder and in the bath are at the same levels, the pressure of the gas in the cylinder corresponds to pressure in laboratory. If levels in the cylinder and in the bath are in different heights, a difference in pressures between inside and outside of the apparatus is made. It is equal to hydrostatic pressure corresponding to difference in heights of water levels. As pressure of 1 bar corresponds (roughly) to 10 m of water column, the difference in water levels of 10 cm leads to pressure difference of ca. 1 kPa (*i.e.* make an error of ≈1 %). Therefore, it is right to move the cylinder in such way to reach the same altitudes of water levels inside and outside the volumetric column, or to calculate appropriate correction for pressure inside the column. To a volume, there is also a contribution caused by a vapour pressure of the closing liquid (water), p_{aq} . Vapour pressure of water is at laboratory temperature 2–3 kPa, so it counts at ambient pressure ≈100 kPa by 2–3 %. Therefore, ideal gas law should be corrected, so:

$$(p - p_{\text{aq}}) \cdot V = n \cdot R \cdot T,$$

and from this equation the molar amount of the gas can be easily calculated.

The dependence of water vapour pressure on temperature is given in [Tab. 6](#).

Tab. 6. Water vapour pressure (p_{aq}) at different temperatures.

| t (°C) | p_{aq} (kPa) | t (°C) | p_{aq} (kPa) | t (°C) | p_{aq} (kPa) |
|----------|-----------------------|----------|-----------------------|----------|-----------------------|
| 0 | 0.6107 | 10 | 1.227 | 20 | 2.337 |
| 1 | 0.6567 | 11 | 1.312 | 21 | 2.486 |
| 2 | 0.7053 | 12 | 1.401 | 22 | 2.642 |
| 3 | 0.7579 | 13 | 1.497 | 23 | 2.809 |
| 4 | 0.8128 | 14 | 1.597 | 24 | 2.982 |
| 5 | 0.8723 | 15 | 1.705 | 25 | 3.167 |
| 6 | 0.9345 | 16 | 1.817 | 26 | 3.360 |
| 7 | 1.001 | 17 | 1.937 | 27 | 3.565 |
| 8 | 1.072 | 18 | 2.062 | 28 | 3.778 |
| 9 | 1.148 | 19 | 2.197 | 29 | 4.005 |

Safety warning

Concentrated hydrochloric acid is fuming and is very corrosive; work with it fast, close the vessels and wash the glassware immediately. Avoid its contact with a skin, alternatively wear gloves. When spilled, wash the skin immediately by strong stream of water.

Procedure

Eudiometric determination of CaCO_3 in sample of marble

Assembly an apparatus according to [Fig. 53](#).

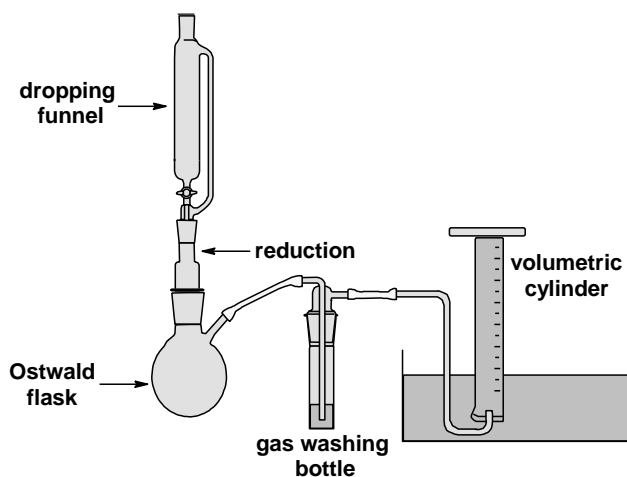

Fig. 53. Apparatus for determination of CaCO_3 content in the sample.

Weight 1.00 g of ground sample. Add it into Ostwald flask (or two/three-necked flask) using funnel and wash remaining material from the funnel with a small amount of water. Make sure, that joints of the flask, dropping funnel and reduction tube are well lubricated by grease. Close the dropping funnel by a stopper with tubing connected to steel gas bomb with CO_2 . Open the valve of the funnel. With help of the teacher, open the valve of the gas bomb (see [Chapter A](#) device called a *refractometer* is used to measure the refractive index. In this practicum, you will use an Abbe refractometer (see [Chapter 3.5.8](#)). When measuring the refractive index, apply a sample onto a perfectly cleaned (and dried) illuminating prism (use such an amount of the sample that when the illuminating prism is covered with the measuring prism, the layer of measured liquid is spread over entire contact area of the prisms; usually a few drops are sufficient). After covering the illuminating prism with the measuring prism and switching on the light, look into the eyepiece. By adjusting (rotating) the optical system of the instrument, the limiting beam of the total internal reflection of light on the thin layer of the sample is measured. If the angle of this limiting beam is θ , then the following relation

applies:

$$n = n_{\text{air}} \cdot \sin \theta.$$

Achieving of total reflection is indicated in the field of view by the relative position of the thread cross and the light/shadow interface shown in [Fig. 42](#). The scale of the device is, for practical reasons, calibrated not in values of the angle θ , but directly in refractive index scale, n (upper scale in the Figure). Usually the device is equipped with another scale, which is used for some of the most common industrial applications, *e.g.* for determination of the sugar content of sugar solutions (lower scale in the Figure).

4.20) and allow a gentle stream of CO_2 passing through the apparatus to ensure saturation of water in the gas washing flask and in the glass bath. The reason is to avoid dissolution of CO_2 evolved during reaction in the water, which would distort the volume measurement. After ca. 5 min close the valve of the bomb. Fill the cylinder (eudiometer) by water. The best way is to lay the cylinder down into the bath in horizontal position to remove bubbles of air and flipping it to vertical direction and fix it by a clamp. Place the end of the tube under lower rim of the cylinder.

Close the valve of the dropping funnel. Measure 10 ml of conc. HCl by a volumetric cylinder and pour it into dropping funnel. *Close the apparatus by a regular stopper.* Add the acid to the sample by a careful opening of the valve of the funnel. After the reaction is finished, measure the volume of CO_2 evolved using eudiometric cylinder.

Measure temperature (as the bath is long-time standing on the place dedicated to this task, the temperature of water is equilibrated with temperature of laboratory) and pressure in the laboratory, and find pressure of water vapours at given temperature in [Tab. 6](#). Calculate molar amount of evolved CO_2 . It is obvious, that this molar amount is equal to molar amount of calcium(II) carbonate present in the sample. Calculate weight of CaCO_3 ($M = 100.09 \text{ g}\cdot\text{mol}^{-1}$) in your sample and mass ratio of CaCO_3 (%) in the marble.

Requirements for acceptance of the results

Calculated percentage of CaCO_3 in the sample of a marble.

Experimental protocol.

5.9 Experiment 9 – Vacuum distillation

Aims

1. Purify given ester of acetic acid by vacuum distillation.
2. Construct chart of time dependence of the boiling point.
3. Determine refractive index of the product.
4. Determine density of the product.
5. Identify the isolated compound based on measured data.

Introduction

Vacuum distillation

As the purified ester boils at normal pressure at a high temperature ($\gg 100\text{ }^{\circ}\text{C}$), vacuum distillation will be used. For principle and description of this technique see [Chapter 4.14.1](#).

Refractive index determination

Description of refractometer and how to work with is given in [Chapter 3.5.8](#), principle of the measurement is described in [Chapter 4.19](#). Ask the teacher for explanation how to operate the refractometer.

Procedure

Vacuum distillation

At first you will remove moisture and mechanical impurities from the given sample. Add ca. 1 g of anhydrous sodium sulphate to 25 ml of the sample poured in Erlenmeyer flask, close the flask by a stopper and shake it. After clarification of the mixture, filter it through a folded (**dry**) filtration paper into 50ml Apollo-shape flask and add a stirring bar. Assemble an apparatus for vacuum distillation and let it check by the teacher. Contrary to [Fig. 32](#) in [Chapter 4.14.1](#) use a short distillation column – place it between the flask with distilled sample and distillation adapter with thermometer. Wrap the column by cotton (or aluminium foil) for thermal isolation. Use a distillation spider equipped with two 10ml and one 25ml tear-shaped flasks; weighted the 25ml flask in advance staying in a beaker together with a stopper. Adjust a gentle stream of water into a cooler (be careful, avoid dropping of water into an oil bath), set appropriate intensity of stirring (the stirring bar should move fast, but regularly without jumping), switch on the vacuum pump and start to evacuate the apparatus by closing the valve of safety flask. Open the valve of manometer – you can check tightness of apparatus by determination of pressure; if a move of mercury in the manometer is small, the apparatus is probably not tightly sealed and you have to fix it. If apparatus is tightly closed, start warming of the oil bath. **Write down pressure and temperature during distillation in intervals of 1 min.** Bath temperature should be in maximum higher by ca. $20\text{ }^{\circ}\text{C}$ than is the boiling point of the product. When higher bath temperature is used, the product can boil too wildly. As you do not still know, what the boiling point will be, you should increase the bath temperature carefully and gradually to avoid sudden and extreme intensive boil. Therefore, set the stirring plate in the beginning to temperature $50\text{ }^{\circ}\text{C}$, and after tempering the bath increase the set temperature with step of $10\text{ }^{\circ}\text{C}$ to assure a smooth boiling. Notice temperature of vapours in the apparatus – low-boiling impurities start to boil with gradual increase in temperature. Collect the first fraction into a 10ml flask until the boiling temperature reach constant value (*i.e.* boiling point of isolated ester). After this turn the distillation spider⁵ connected to collection adapter, change collection flask to in-advance-

⁵ If distillation spider (splitter) is absent, a change of collecting flasks should be performed in a following way: close the valve of manometer – it disconnects it from the apparatus, and avoids risk of broking manometer's tube

weighted 25ml flask and distil the product. When distillation is over, stop it – at first close the valve of the manometer, let air in the apparatus by opening of valve of safety flask, switch off the pump and water and open the disconnected manometer to air carefully in such a way to reach slow return of the mercury column (it avoids broking of the manometer’s tube). Weight the flask with product (closed and standing in the beaker). Determine refractive index of the distillate.

Wash oil remaining from the outside wall of the flask by hot water and detergent, wash inside of the flask by ethanol. Wash all other vessels which were in contact with sample/product by ethanol.

Calibration of automatic pipette

During this Task, you do not use pycnometer for measurement of volume (pycnometers have usually too big volume, mostly 25 ml and more), but from the reason of small loss of the product you will measure volume using a 1ml piston pipette (see [Chapter 4.3](#)). Sometimes the volume declared on the pipette differs slightly from the real pipetted volume, so, for the exact measurement you should do the calibration of the volume. You will use distilled water. Pipette 1 ml of water into the weighted vial (**use analytical balances**). **Attention, declared volume corresponds to the first position of the piston!** Determine the weight of pipetted water. Repeat the determination five times and average the values (use “Tare” between individual weightings, add a new portion of water into the vial without removing of previous batch). Average weights. If some result differs from the average by more than $\pm 0.5\%$, repeat the measurement. Determine the temperature of used water using thermometer (place thermometer into water in such a way, that mercury container will be under layer of water and does not contact with walls of the vessel). If the temperature will not be integer, interpolate a value of density from edge values listed in the table. Densities of water in dependence on temperature are outlined in [Tab. 7](#). Use averaged volume and water density for calculation of the exact volume of the pipette. **If the volume you get differs from declared volume of 1.000 ml by more than 2%, you probably did pipetting in a wrong way. In such case consult your technique with the teacher.**

Tab. 7. Temperature dependence of water density.

| t (°C) | ρ (g·cm ⁻³) | t (°C) | ρ (g·cm ⁻³) |
|----------|------------------------------|----------|------------------------------|
| 15 | 0.999099 | 23 | 0.997536 |
| 16 | 0.998943 | 24 | 0.997299 |
| 17 | 0.998775 | 25 | 0.997047 |
| 18 | 0.998596 | 26 | 0.996786 |
| 19 | 0.998406 | 27 | 0.996515 |
| 20 | 0.998205 | 28 | 0.996235 |
| 21 | 0.997994 | 29 | 0.995946 |
| 22 | 0.997772 | 30 | 0.995649 |

Determination of density of the product

Pipette 1.000 ml of the product into weighted (using analytical balances) clean and dry vial using calibrated automatic pipette. Weight the vial again. Determine the weight five times, and average the values. If some result differs from the average by more than $\pm 1\%$, repeat the measurement. Calculate density of the product.

by fast moving mercury column if loss of vacuum would be fast; fill the apparatus with air by opening of valve of safety flask or by careful disconnecting rubber tubing between the pump and the adapter, change the collecting flask and start evacuation again. A change of the flasks must be performed as quickly as possible to avoid overheating of the distilling mixture – in other case, too intensive boil can occur after repeated evacuation with spitting of distilled mixture into a condenser. After evacuation connect the manometer.

Identification of the product

Identify the product by comparison of measured data with values outlined in [Tab. 8](#).

Tab. 8. Values of refractive index $^{20}n_D$ and density ρ of acetic acid esters – possible samples.

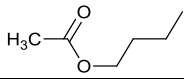
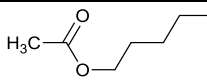
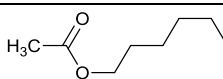
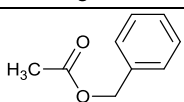
| ester | formula | $^{20}n_D$ | ρ (g·cm ⁻³) |
|----------------|---|------------|------------------------------|
| butyl-acetate |  | 1.394 | 0.883 |
| pentyl-acetate |  | 1.402 | 0.876 |
| hexyl-acetate |  | 1.409 | 0.867 |
| benzyl-acetate |  | 1.502 | 1.054 |

Requirements for acceptance of the results

Weighted clean product.

Boiling point of the product at used low pressure.

Refractive index of the product.

Determined density of the product.

Identification of the product. **Pour the product into an appropriate collecting bottle only after teacher's agreement with product's identification!**

Experimental protocol. Mandatory part of the protocol is a chart showing a course of distillation.

5.10 Experiment 10 – Determination of solubility of inorganic salt, and determination of content of water of crystallization in the solid sample

Aims

1. Determine solubility of given sample of inorganic salt in water at laboratory temperature.
2. Identify the unknown sample based on its solubility.
3. Determine number of molecules of water of crystallization in given solid sample.

Introduction

Solubility of ionic substances

Equilibrium in closed system must fulfil special rule defined in end of 19th century by American mathematics and physicist Josiah Willard Gibbs (1839–1903). Such rule is called *Gibbs law of phases (phase rule)*:

$$P + F = C + 2,$$

where P is a number of *phases* in the system, F is a number of *degrees of freedom* and C is a number of *chemical constituents* in the system. A phase is each homogenous part (gas, liquid, solid phase) of the system and chemical constituent is each present chemical compound. Degree of freedom is any *intensive* physical variable (*i.e.* variable, which does not depend on total mass of the system; intensive variables are for example temperature, pressure, density, concentration *etc.*).

For pure liquid, $P = 1$ and $C = 1$ and, therefore, $F = 2$. You can choose two independent variables for given liquid (*e.g.* temperature and pressure), and values of other variables are conditionally given (*e.g.* density). During heating of the liquid to its boiling point, the second (gas) phase is formed, *i.e.* $P = 2$, $C = 1$, and such system has only one degree of freedom ($F = 1$). Therefore, at given pressure, the boiling point is exactly given by value of pressure (and oppositely, if we want to set boiling point to required temperature, the pressure must be changed to well-defined value). Similarly, for pure solid compound ($C = 1$) is at given pressure its melting point constant (at melting point, two phases – solid and liquid – coexist, $P = 2$, and therefore, $F = 1$).

In the case of solution of some compound in the solvent, $C = 2$ (constituents are dissolved compound as well as solvent) and $P = 1$ (there is only one homogenous phase – solution), and number of degrees of freedom is $F = 3$. At given temperature and pressure, the third parameter can be chosen – *e.g.* concentration. It is the case of for example two unlimitedly miscible liquids, *e.g.* water and ethanol.

Other situation occurs when dissolving compound is not unlimitedly miscible with the solvent. When *e.g.* salt will be gradually added to water, it dissolves until a critical concentration is reached. Further addition of salt does not dissolve and heterogeneous mixture of liquid and solid is obtained. For such a mixture, $C = 2$ and $P = 2$, and number of degrees of freedom is $F = 2$. At given temperature and pressure is therefore concentration of *saturated* solution conditionally defined and it is constant. Concentration of the saturated solution is called *solubility*, and saturated solution is such a solution, in which (at given temperature and pressure) equilibrium between solution and solid phase is reached. However, the equilibrium is not static, but some solid material still dissolves, and some ions from solution are deposited into a crystal lattice. At equilibrium, rates of both processes are equal. Therefore, for general salt X_xY_y , following equation can be written:

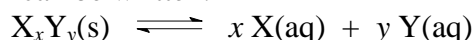

[charges of individual ions are omitted, and expressions (s) and (aq) mean, that given substance/ion are present in the solid phase or dissolved in aqueous solution].

The product $P = [X]^x \cdot [Y]^y$ is (at given temperature and pressure) for a given substance constant. The variable P (sometimes labelled as K_s) is called *solubility product*.

The solubility products are usually tabulated for poorly soluble compounds, so it is very low and therefore, it is usually presented in the form of negative logarithms, e.g. $P(\text{AgCl}) = K_s(\text{AgCl}) = 1.78 \cdot 10^{-10}$, $-\log\{P(\text{AgCl})\} = pP(\text{AgCl}) = pK_s(\text{AgCl}) = 9.75$.

The solubility can be expressed also by different ways. One other possibility is molar solubility S , which is molar concentration of the saturated solution. The solubility of well soluble materials can be given also in molality (*i.e.* in moles of the compound dissolved in 1 kg of the solvent), or in weight fraction (grams of compound in 100 g of the solution), or in grams of compound in 100 ml of the solvent or solution, or in grams of compound in 100 g of the solvent. For conversion between different values it is needed to know a density of the saturated solution.

In this Task, you will determine solubility of well soluble inorganic salt.

Water of crystallization

In some cases, water molecules (or, in general, solvent molecules) are incorporated into a lattice of the ionic compound during its crystallization from the solution. Such water molecules can be bounded in the lattice by different modes – e.g. by coordination to cation, by hydrogen bonds to anions, by hydrogen bonds between each other, *etc.* Sometimes, in dependence on temperature of crystallization process, different solid phases are crystallized out, differing in a number of water molecules per formula unit of the salt. For example, sodium carbonate (Na_2CO_3 , washing soda) crystallizes (based on conditions) in the form of monohydrate, heptahydrate or decahydrate. Even table salt (sodium chloride, NaCl), which is well known and standardly used in its anhydrous form, crystallizes at temperature below 0 °C in form of dihydrate, $\text{NaCl} \cdot 2\text{H}_2\text{O}$.

Some of crystalline hydrates can (at least partly) loose some of water of crystallization during storage.

Work with piston pipette

For description of this technique see [Chapter 4.3](#).

Annealing in flame of gas burner and annealing to the constant weight

For description of these techniques see [Chapter 4.7.1](#). After annealing till constant weight **use the last weight obtained. Do not average last two values.** Although this fact is obvious, related mistake is appearing rather frequently in the protocols.

Procedure

The sample is given as aqueous suspension in labelled 250ml Erlenmeyer flask and in the form of solid material in the flask with the same code as given for the suspension. **Check, that there is also undissolved solid material beside liquid phase in the Erlenmeyer flask.** Plan the work on individual sub-tasks in such a way that you will reasonably use your time spent in the practicum during annealing/cooling of the crucibles.

Determination of number of molecules of water of crystallization

Anneal two small **labelled** (by marker or pencil) crucibles till constant weight in the oven set to 400 °C. Left individual annealing for 10 min, put crucibles into a desiccator using tongs and let them cool down to laboratory temperature. Be careful, **after you will close the desiccator with hot content** it will be inside slightly pressurized ($p \cdot V = n \cdot R \cdot T$) and viscosity of grease used for sealing of joints will be lowered due to slight warming and, therefore, the **cover of the desiccator can slide down**. Therefore, hold the desiccator's cover by hand and after a short while (20 s) open it just for balancing the pressure. **Use analytical balances for weighting. Carry out all weightings using the same balances.**

Weigh ca. 0.25 g of the solid sample as accurately as possible into the crucibles. The phrase “ca. ... as accurately as possible” means about this value, but with maximal accuracy – in this case it means to weigh the sample on analytical balances **with accuracy on four decimal places**. Anneal the samples for 10 min at 400 °C in the oven. Put crucibles into a desiccator using tongs and let them cool down to laboratory temperature. Weight the crucibles using analytic balances and repeat annealing for next 10 min. Let the crucibles cool down in the desiccator and weight again. If the weight obtained after the second annealing differs from the first weighting by more than ± 1 mg, anneal the crucibles again for next 10 min till constant weight will be reached.

From the weight lost determine content of water present in the solid sample per formula unit of the salt (*i.e.* number of water molecules of crystallization). To finish this calculation you need to know result of following sub-task (identity of the sample).

Determination of solubility and identification of the sample

Anneal three big **labelled** (by marker or pencil) crucibles to constant weight using Méker gas burner. Notice the remarks mentioned above in instructions for determination of content of water of crystallization.

Stir the suspension of the sample and measure its temperature by thermometer – thermometer attach to a stand via clamp and immerse it into suspension of the sample in such way, that mercury bulb will be under surface of the suspension but does not touch the walls of the flask. Leave the thermometer immersed at least for 5 min before reading of temperature.

Using piston pipette, measure 5.00 ml of liquid phase from the suspension sample into each of three crucibles. Be careful to avoid sucking of solid material from the suspension into the pipette’s tip. **Pay attention, the volume set on the pipette corresponds to the first position of the pipette’s piston (push-button)! Weight** the crucibles with sample solution **on the analytical balances**. Place the crucibles onto ceramic net and heat them by non-luminous flame of the gas burner. Take care that solution will boil only gently and material does not be spitted around. Intensity of heating can be easily regulated by keeping the burner in the hand and moving it. After volatiles will be removed, put the heater directly below the net with crucibles and anneal the sample at highest possible temperature for 10 min. Let the crucibles cool down in the desiccator.

Weight the cooled crucibles and anneal them again for next 5 min. Let them cool down in the desiccator and weight them again. If the weight obtained after the second annealing differs from the first weighting by more than 3 mg, anneal the crucibles again for next 5 min till constant weight will be reached.

Calculate weight of the solid remaining in the crucibles. In the case, that weight of one of the three samples differs significantly ($>5\%$) from two others, exclude such value from further calculations. If all weights significantly differ from each other, repeat all experiment with new three liquid samples.

Calculate solubility of the sample. Present results in grams of the dissolved material per 100 ml of solution, in grams of dissolved material per 100 g of solution, in grams of dissolved material per 100 g solvent (water), in molarity ($\text{mol}\cdot\text{dm}^{-3}$) and in molality ($\text{mol}\cdot\text{kg}^{-3}$). Calculate also density of the saturated solution at room temperature (in $\text{g}\cdot\text{cm}^{-3}$).

Wash the crucibles and let them dry out.

Using entries outlined in [Tab. 9](#) identify your unknown sample.

Tab. 9. Solubility of salts (calculated for anhydrous formulas). The values are given in grams of anhydrous salt dissolved in 100 g of water.

| salt | M_r | temperature (°C) | | | | | | | | | |
|---------------------------------|--------|------------------|------|------|------|------|------|------|------|------|------|
| | | 18 | 19 | 20 | 21 | 22 | 23 | 24 | 25 | 26 | 27 |
| Li ₂ SO ₄ | 109.94 | 34.6 | 34.5 | 34.4 | 34.4 | 34.3 | 34.3 | 34.2 | 34.2 | 34.1 | 34.1 |
| Na ₂ SO ₄ | 142.04 | 16.4 | 17.7 | 19.1 | 20.6 | 22.2 | 23.9 | 25.8 | 27.9 | 30.1 | 32.5 |
| MgSO ₄ | 120.36 | 32.3 | 32.9 | 33.5 | 34.0 | 34.6 | 35.2 | 35.8 | 36.3 | 36.9 | 37.5 |
| MgCl ₂ | 95.21 | 54.2 | 54.3 | 54.4 | 54.6 | 54.7 | 54.8 | 54.9 | 55.0 | 55.2 | 55.3 |
| CaCl ₂ | 110.98 | 72.6 | 74.0 | 75.5 | 77.2 | 78.9 | 80.7 | 82.7 | 84.8 | 87.0 | 89.3 |
| Na ₂ CO ₃ | 105.99 | 19.4 | 20.6 | 21.8 | 23.2 | 24.6 | 26.2 | 27.8 | 29.6 | 31.4 | 33.4 |

If you are not sure about identity of the sample, determine present cation using a *flame test*. Atoms of a number of metals (especially of alkaline and alkaline earth metals) and of several other elements are excited at flame temperature. They shine the excitation energy during relaxation in form of visible photons with corresponding wavelength. This phenomenon is frequently used in amusing pyrotechnics – flashes are coloured according to used cation/element present in pyrotechnic mixture.

Flame test is performed by following procedure: anneal a wire made of inert material (*e.g.* platinum,⁶ but it is possible to use a steel wire, *e.g.* paper clip, or pencil lead) in a colourless flame of a gas burner until it stops to colourize the flame. It is recommended to dip the wire during annealing by diluted solution of hydrochloric acid – besides washing of the wire it converts present metal ions in chloride salts, which are in general volatile. Take solution of the unknown sample on the annealed wire and put it back to the colourless flame. The present metal cation can be determined by a colour of the flame.

In presence of individual metal ions you can see *e.g.* lilac (potassium), carmine red (lithium), red (brick red – calcium, scarlet – strontium), yellow (sodium), green (barium, manganese or boron), blue-green (copper) *etc.* Presence of magnesium is not observed by a flame test.

You can compare a colour of flame in presence of your unknown sample with standards containing lithium, sodium or calcium, which are available in bottles on a shelf.

Requirements for acceptance of the results

Solubility of the sample presented in all required units.

Density of the saturated solution at room temperature.

Identity of the unknown sample.

Calculated number of water molecules of crystallization.

Experimental protocol.

⁶ Platinum object cannot be annealed in shiny flame – carbon microparticles present in the flame react with platinum and the material become brittle.

6. Example of protocol

Experiment 1: Preparation of sodium chloride

John Smith, workgroup ST-II-15B4/3Ψ

Date 1. 1. 1999

Our aim was preparation of sodium chloride by reaction of sodium carbonate with hydrochloric acid.

Introduction and theoretical principles

The reaction proceeds according to equation:

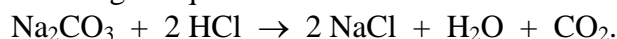

Crude carbonate contains some mechanical impurities and, therefore, its solution has to be filtered through filtration paper. The final product will be precipitated from its aqueous solution by addition of ethanol; solubility of NaCl in ethanol is low. For concentration of the reaction mixture, *vacuum rotary evaporator* (VRE, Fig. 1) will be used. The equipment works on the following principle: inside rotating flask, film of the solution is continuously made on the walls due to rotation. Application of vacuum leads to fast evaporation of the solvent from the film. Therefore, it leads to fast concentration of the solution below boiling point of the solvent. It is recommended to observe following rules, which avoid bubbling and spitting of the evaporating mixture: fasten the round-bottom flask with solution to glass tube of VRE. Start spinning of the flask. Switch on the vacuum pump. Close valve of the VRE and wait until the solution will stop spitting (during this stage, it is sometimes necessary to open the valve and let some air inside the VRE, as in other case, the mixture could spit to condenser). When evaporated solution stop bubbling, dip the flask into water bath of the VRE (for evaporation of water set the bath temperature to 60–70 °C) and wait until volatiles will be evaporated off. Switch on the cooling water. After evaporation, move the flask out from the bath, open the valve, stop rotation and stop water. Remove the flask from the tube. Switch off the pump as the very last step when the apparatus is fully equilibrated towards external atmosphere.

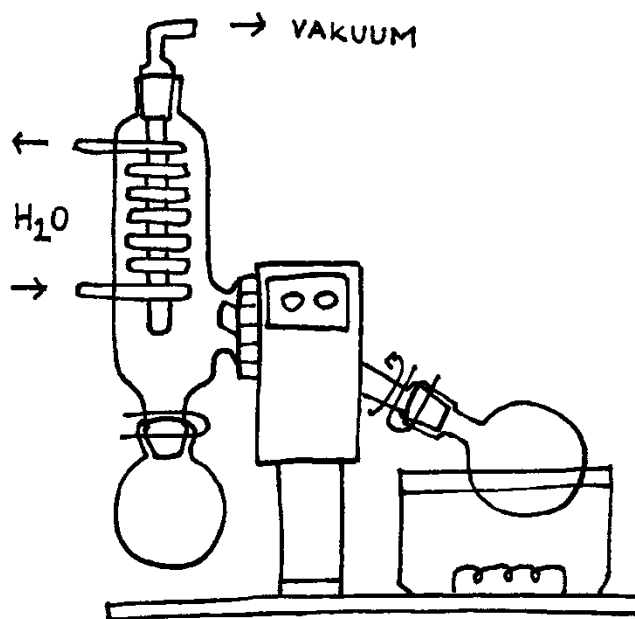

Fig. 1: Vacuum rotary evaporator (VRE).

Procedure

Sodium carbonate decahydrate ($\text{Na}_2\text{CO}_3 \cdot 10\text{H}_2\text{O}$, 10.0 g $M_r = 286.08$, 35.0 mmol) was dissolved in 250ml beaker in 50 ml of distilled water. To this solution, diluted solution of HCl prepared from 6.6 ml of conc. HCl (36%, $\rho = 1.18 \text{ g} \cdot \text{cm}^{-3}$, 75.6 mmol, 2.2 eq., 10% excess) and 20 ml of water. The reaction mixture intensively bubbled during acid addition and some foam was formed. After addition of all acid, pH of the reaction mixture was checked by pH-paper; pH was about 2. To the solution, a small portion of active carbon (one small spoon) was added and the mixture was intensively stirred. The mixture was filtered through filtration paper into 250ml round-bottom flask and volatiles were evaporated off using VRE. Distilled water was portion-wise added to the yellowish solid residue until all material was dissolved (ca. 15 ml of H_2O). The product was precipitated off by addition of ethanol (100 ml). The precipitate was collected on the frit S3, washed with 10 ml of ethanol, and dried by air-flow for 5 min. Yield of NaCl was 2.86 g (70 %).

Calculations

10.0 g of $\text{Na}_2\text{CO}_3 \cdot 10\text{H}_2\text{O}$ corresponds to $n = 10.0 \text{ g} / 286.08 \text{ g} \cdot \text{mol}^{-1} = 0.0350 \text{ mol}$.

Due to a stoichiometry of the reaction $n(\text{NaCl}) = 2n(\text{Na}_2\text{CO}_3 \cdot 10\text{H}_2\text{O}) = 0.0699 \text{ mol}$, which corresponds ($M(\text{NaCl}) = 58.44 \text{ g} \cdot \text{mol}^{-1}$) to theoretical weight:

$m(\text{NaCl}) = 0.0699 \text{ mol} \cdot 58.44 \text{ g} \cdot \text{mol}^{-1} = 4.09 \text{ g}$ (yield 100%).

Theoretical amount of hydrochloric acid required for the reaction is $n(\text{HCl}) = 0.0699 \text{ mol}$, which corresponds ($M(\text{HCl}) = 36.46 \text{ g} \cdot \text{mol}^{-1}$) to weight:

$m(\text{HCl}) = 0.0699 \text{ mol} \cdot 36.5 \text{ g} \cdot \text{mol}^{-1} = 2.55 \text{ g}$ of pure HCl.

Suggesting concentration 36%, it corresponds to $m(36\% \text{ HCl}) = 2.55 \text{ g} / 0.36 = 7.09 \text{ g}$. Taking into account density of concentrated acid $\rho(36\% \text{ HCl}) = 1.18 \text{ g} \cdot \text{cm}^{-3}$ it corresponds to 6.01 ml. Excess of 10% gives 6.6 ml.

Yield 2.86 g of NaCl correspond to $100\% \cdot 2.86 \text{ g} / 4.09 \text{ g} = 69.9\%$.

Summary

Sodium chloride (2.86 g, yield 70%) was prepared by reaction of sodium carbonate with hydrochloric acid. Relatively low yield is given by partial solubility of NaCl in aqueous ethanol.

7. Time schedule for performing experiments

Number of experiment which you should pass in given week is in the cross of appropriate row with number of your working group (pair) and a column with ordinal number of the week.

7.1 Time schedule for “Laboratory technique (a)”

| LT | | Week | | | | | | | | | |
|-------|----|------|----|----|----|----|----|----|----|----|----|
| | | 1 | 2 | 3 | 4 | 5 | 6 | 7 | 8 | 9 | 10 |
| Group | 1 | 1 | 2 | 3 | 4 | 5 | 6 | 7 | 8 | 9 | 10 |
| | 2 | 2 | 3 | 4 | 5 | 6 | 7 | 8 | 9 | 10 | 1 |
| | 3 | 3 | 4 | 5 | 6 | 7 | 8 | 9 | 10 | 1 | 2 |
| | 4 | 4 | 5 | 6 | 7 | 8 | 9 | 10 | 1 | 2 | 3 |
| | 5 | 5 | 6 | 7 | 8 | 9 | 10 | 1 | 2 | 3 | 4 |
| | 6 | 6 | 7 | 8 | 9 | 10 | 1 | 2 | 3 | 4 | 5 |
| | 7 | 7 | 8 | 9 | 10 | 1 | 2 | 3 | 4 | 5 | 6 |
| | 8 | 8 | 9 | 10 | 1 | 2 | 3 | 4 | 5 | 6 | 7 |
| | 9 | 9 | 10 | 1 | 2 | 3 | 4 | 5 | 6 | 7 | 8 |
| | 10 | 10 | 1 | 2 | 3 | 4 | 5 | 6 | 7 | 8 | 9 |
| | 11 | 1 | 2 | 3 | 4 | 5 | 6 | 7 | 8 | 9 | 10 |
| | 12 | 2 | 3 | 4 | 5 | 6 | 7 | 8 | 9 | 10 | 1 |
| | 13 | 3 | 4 | 5 | 6 | 7 | 8 | 9 | 10 | 1 | 2 |
| | 14 | 4 | 5 | 6 | 7 | 8 | 9 | 10 | 1 | 2 | 3 |
| | 15 | 5 | 6 | 7 | 8 | 9 | 10 | 1 | 2 | 3 | 4 |
| | 16 | 6 | 7 | 8 | 9 | 10 | 1 | 2 | 3 | 4 | 5 |

7.2 Time schedule for “Laboratory technique (b)”

| LT | | Week | | | | |
|-------|----|------|---|---|---|---|
| | | 1 | 2 | 3 | 4 | 5 |
| Group | 1 | 1 | 2 | 3 | 4 | 5 |
| | 2 | 2 | 3 | 4 | 5 | 1 |
| | 3 | 3 | 4 | 5 | 1 | 2 |
| | 4 | 4 | 5 | 1 | 2 | 3 |
| | 5 | 5 | 1 | 2 | 3 | 4 |
| | 6 | 1 | 2 | 3 | 4 | 5 |
| | 7 | 2 | 3 | 4 | 5 | 1 |
| | 8 | 3 | 4 | 5 | 1 | 2 |
| | 9 | 4 | 5 | 1 | 2 | 3 |
| | 10 | 5 | 1 | 2 | 3 | 4 |